

Architectural Views

Presentation to Architecture Forum

JCSE

Ardhendu Patri, Reverside

Architectural Views

SETTING THE SCENE

Engineering Drawing – Air Equipment

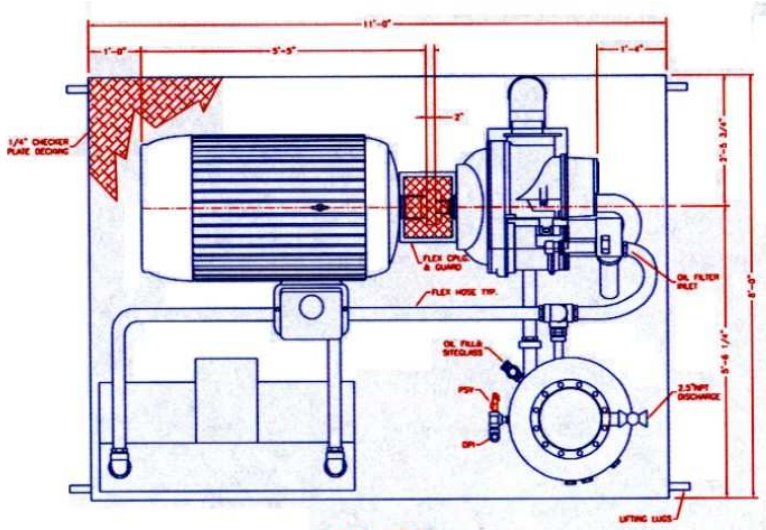

PLAN VIEW
R.T.S.

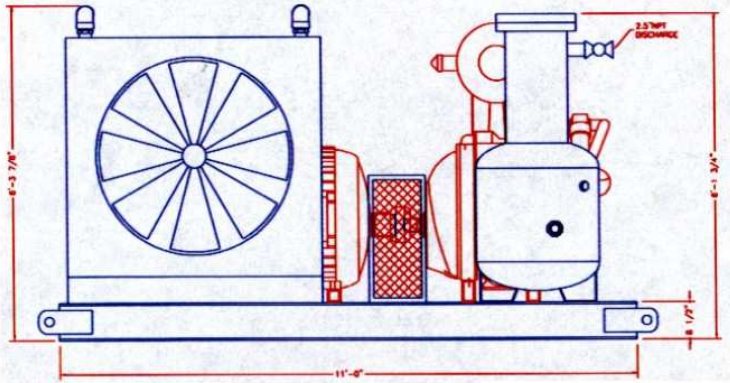

ELEVATION VIEW

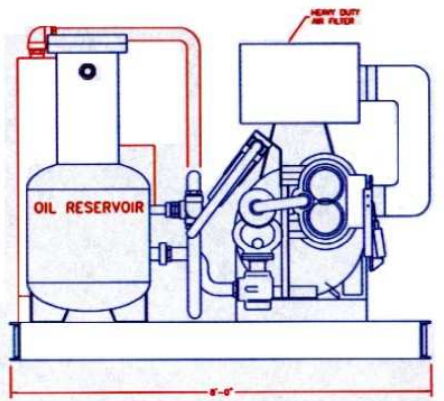

SIDE VIEW
R.T.S.

Building Architecture

ARCHITECTURA ET AMICITIA.

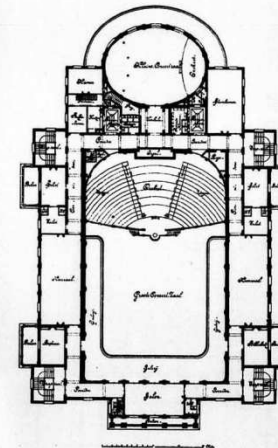
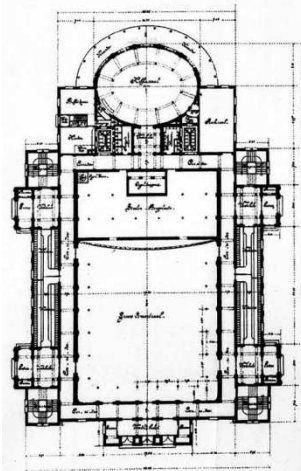
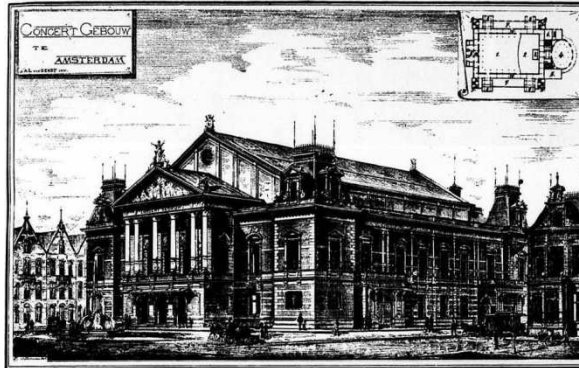

Photolith. v. G. J. Thome, Arnhem.

DE OPMERKER N° 1 van 7 Januari 1888.

Architectural Views

REQUIREMENTS

Functional Requirements

- System must provide –
 - Web based content authoring, content approval workflow and publishing of content
 - Personalization of content for users
 - Deliver new media services in an integrated fashion
 - Common look and feel theme for the content aggregated from various sources
 - Transactional services

Functional Requirements (contd ...)

- System must provide –
 - Enterprise Search
 - Classification
 - Collaboration
 - Content Management
 - Rich User Interface

Non-functional Requirements

- System should
 - Provide adequate level of security for an internet facing and intranet facing application hosting environment
 - Be highly available and scalable as per a pre-determined usage scenario
 - Be usable (very high usability)
 - Be highly reliable
 - Have high performance/throughput
 - Have good supportability

Technology Requirements

- System should be
 - Futuristic (SOA-enabled)
 - Aligning with organizational architecture
 - Interfacing cleanly with various components
 - Vendor-agnostic open standard solution
 - A device independent solution so that multiple device interfaces can access content
 - Able to aggregate content from the existing applications

Architectural Views

METHODOLOGY

TOGAF – Architecture Development

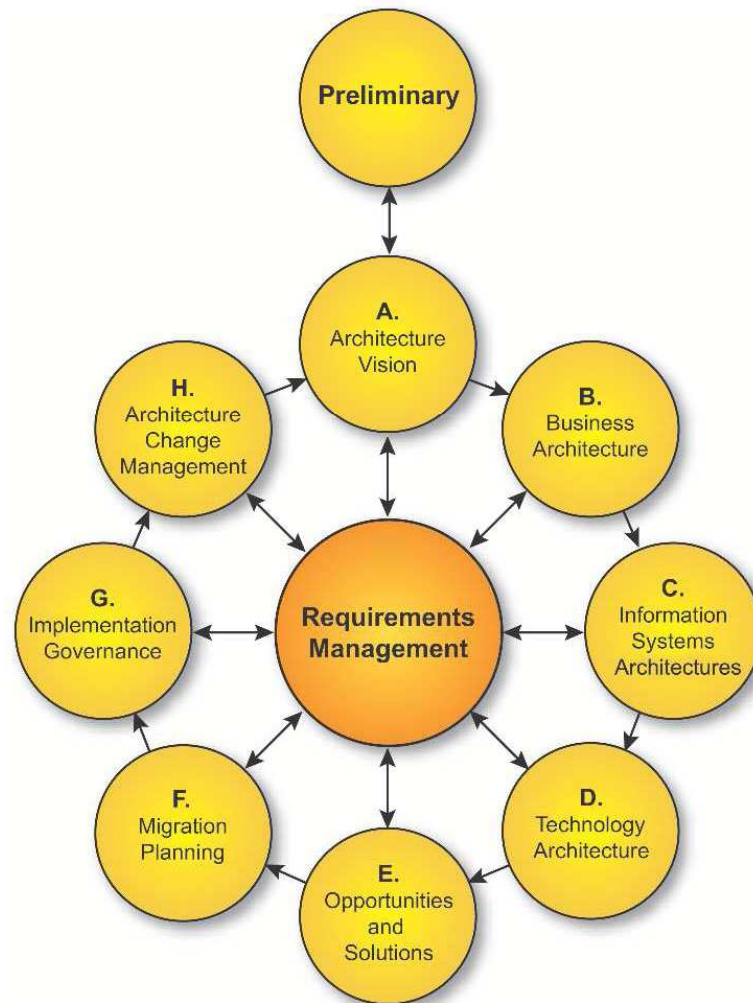

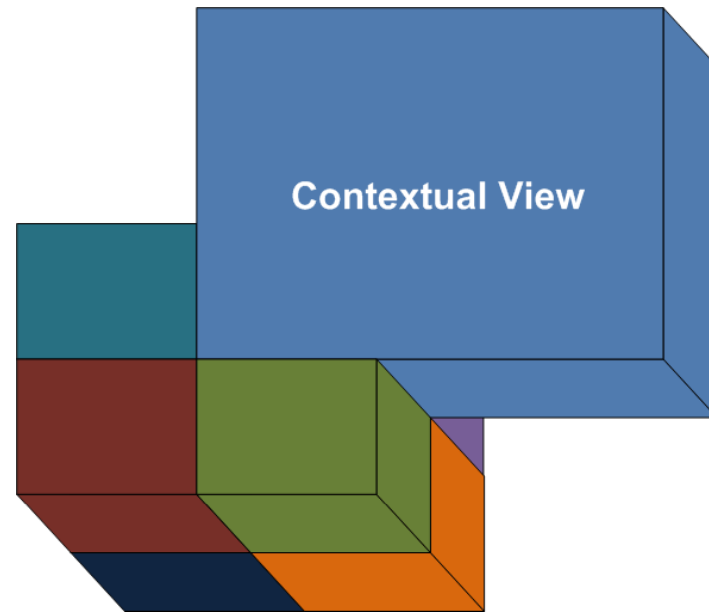

Architectural Views

CONTEXTUAL VIEWS

IT vs Business

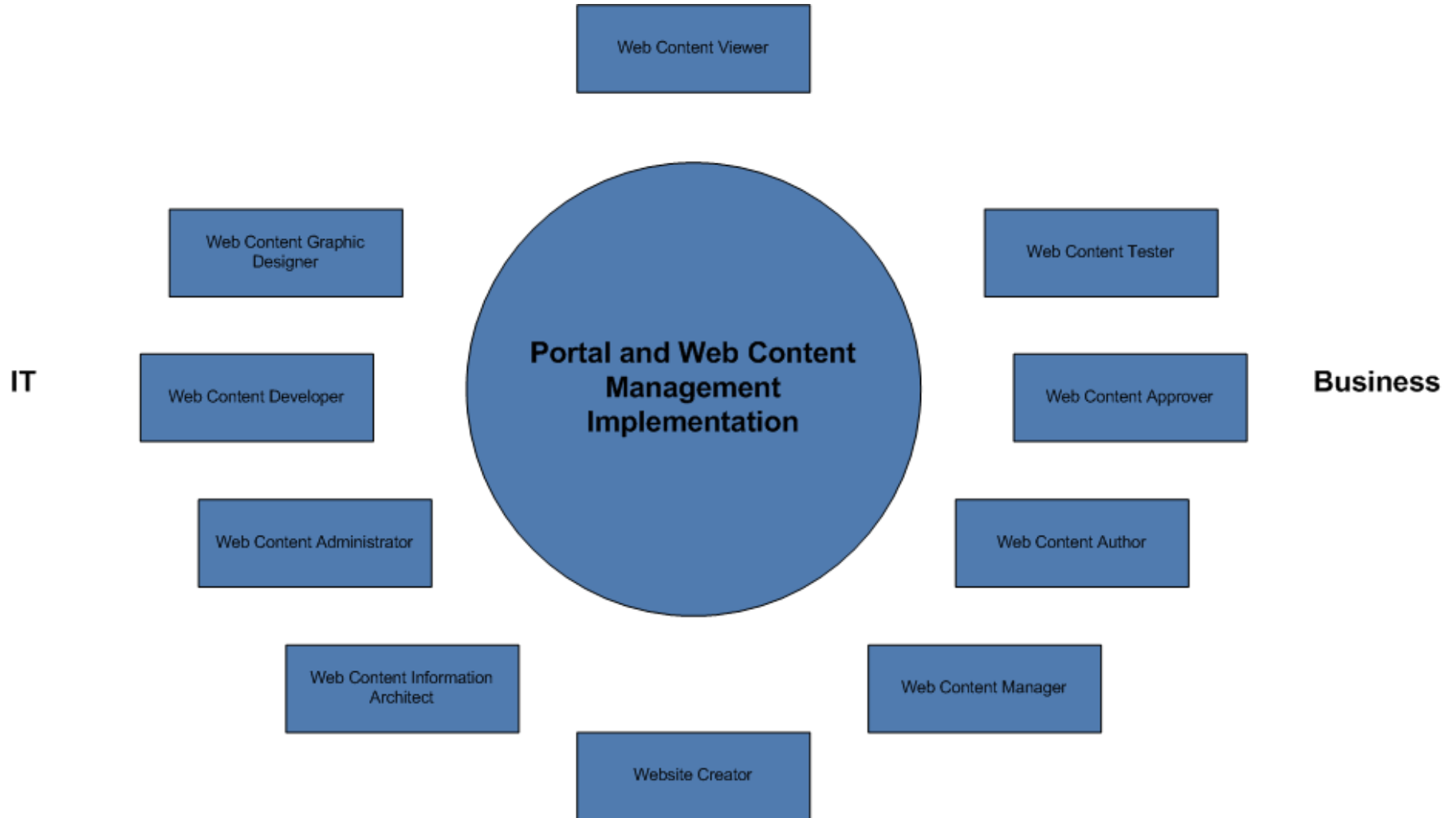
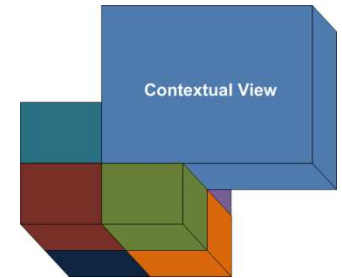

People vs Systems

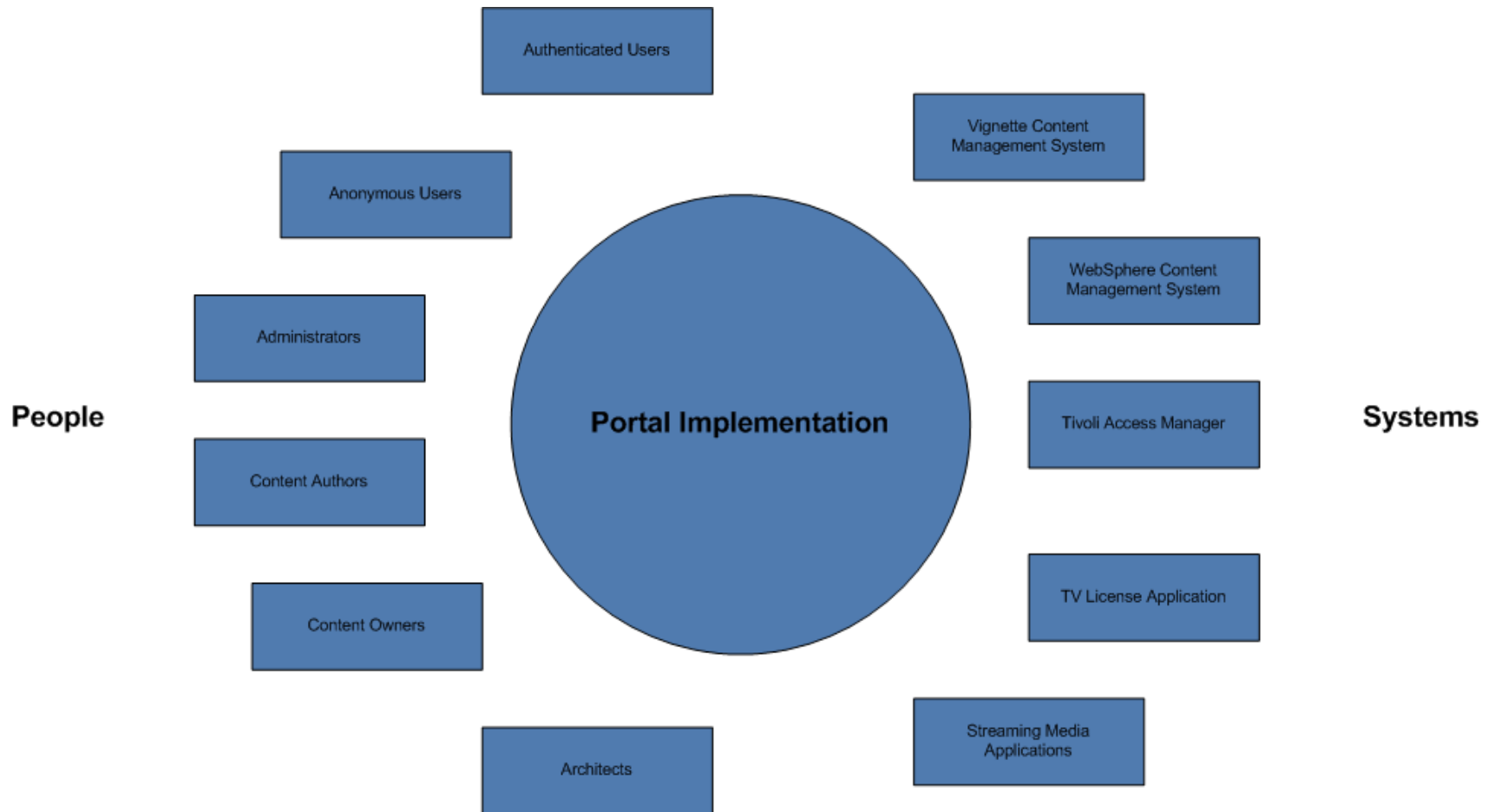
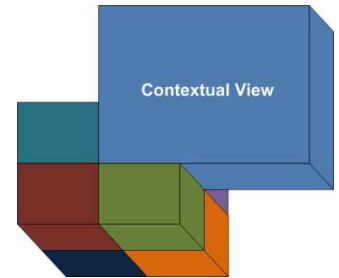

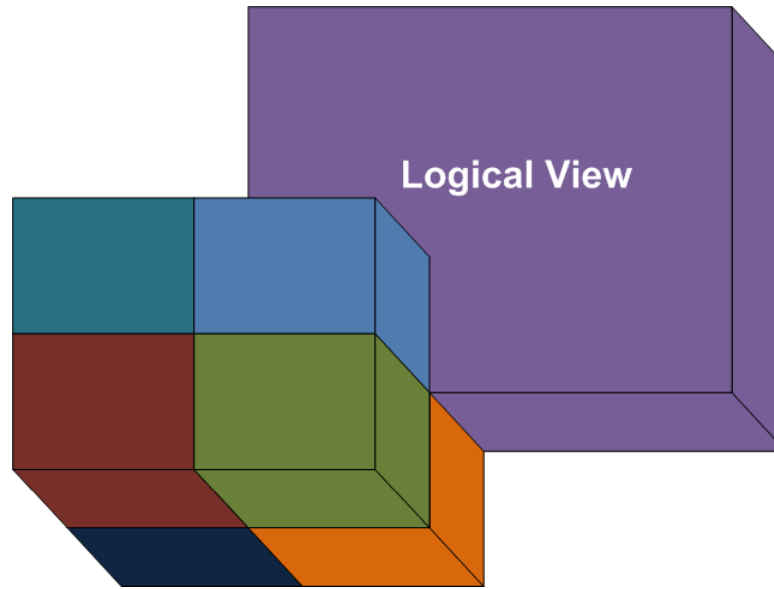

Architectural Views

LOGICAL VIEWS

High Level Block Diagram

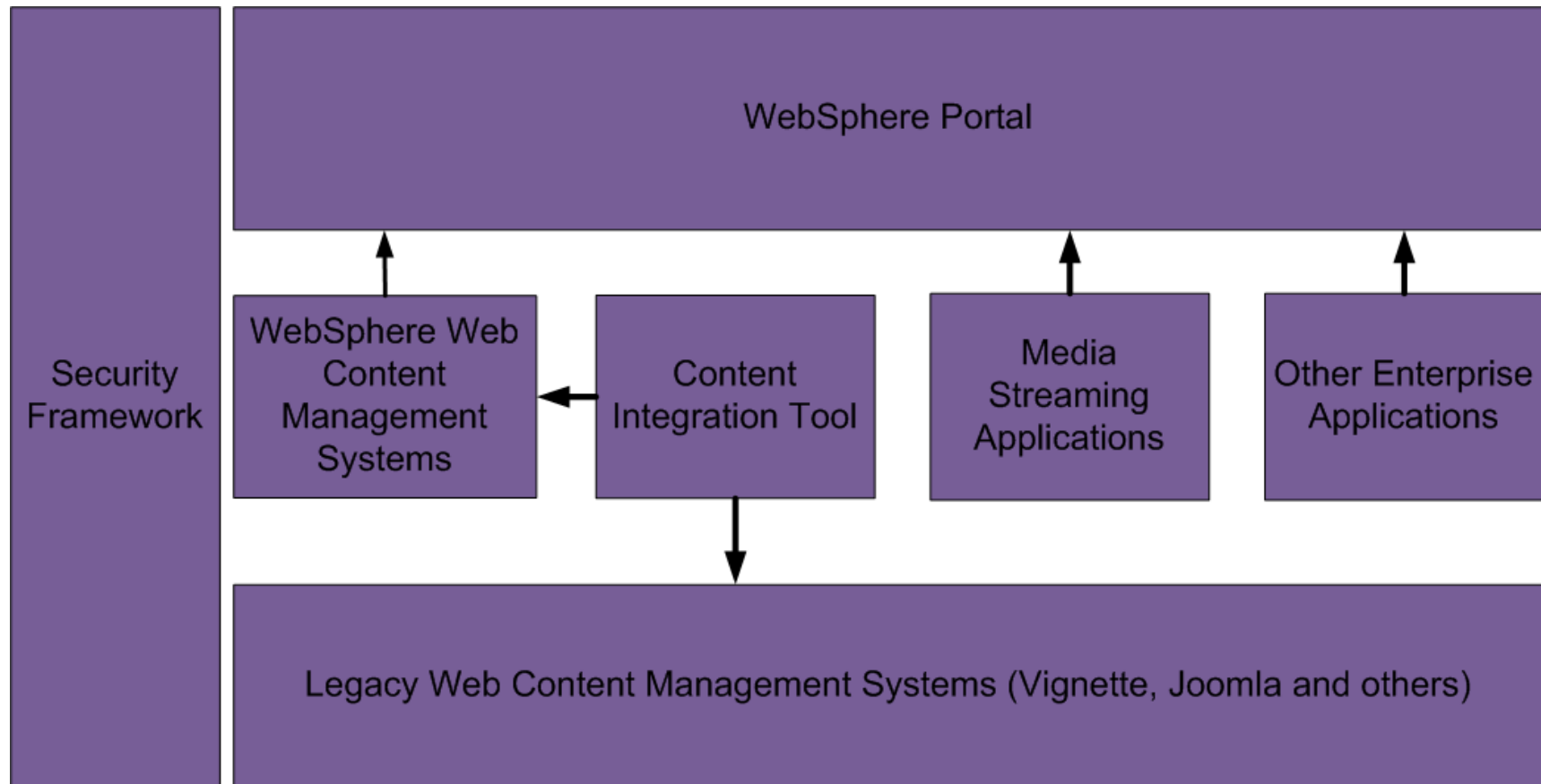
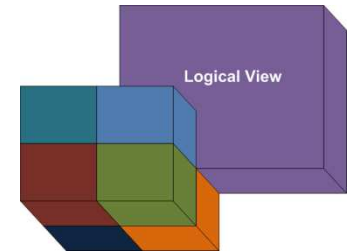

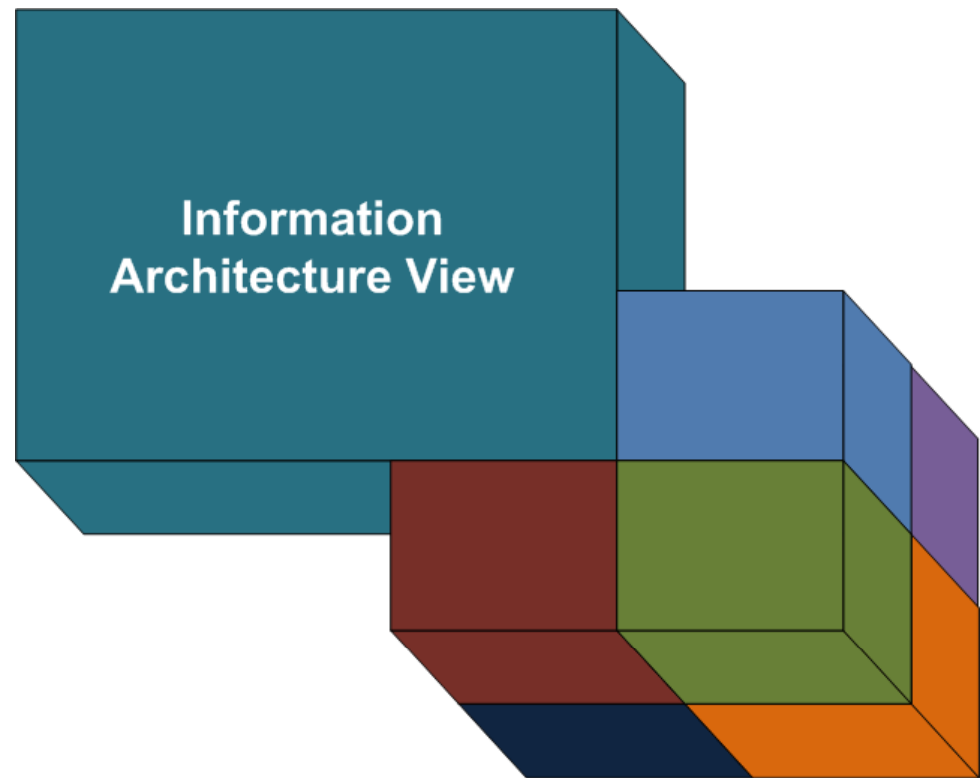

Architectural Views

INFORMATION ARCHITECTURE VIEWS

Information Architecture

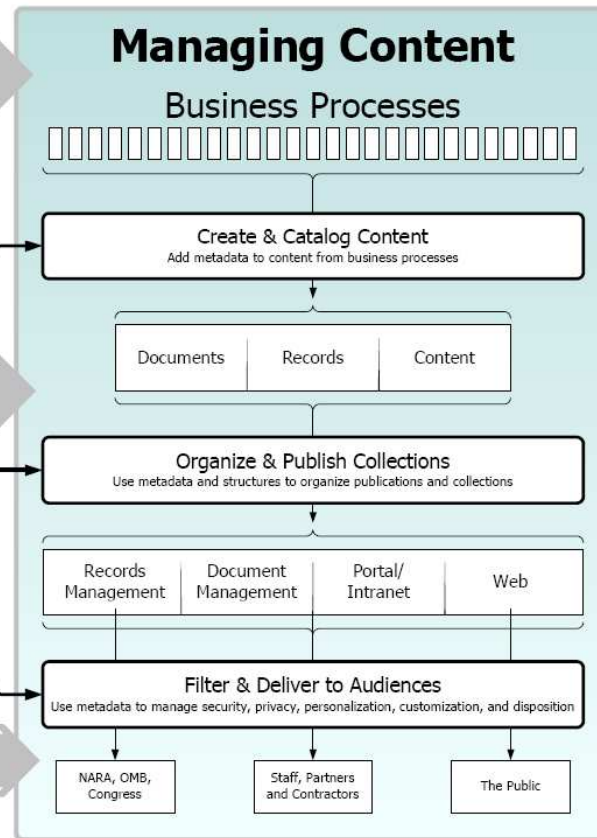
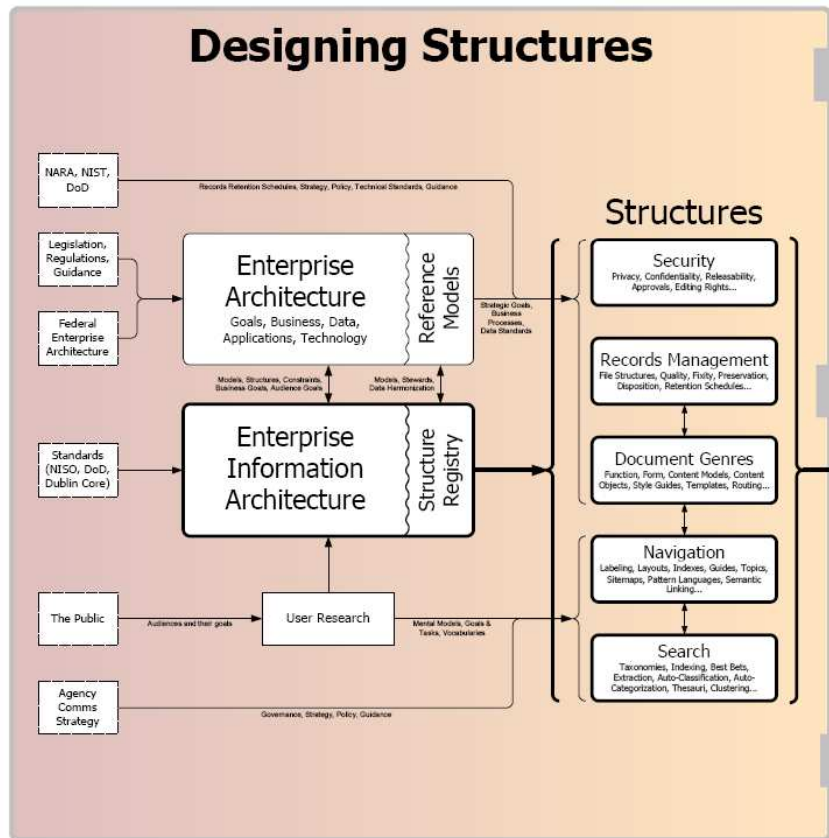
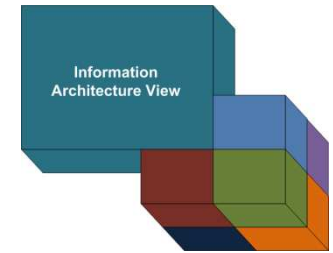

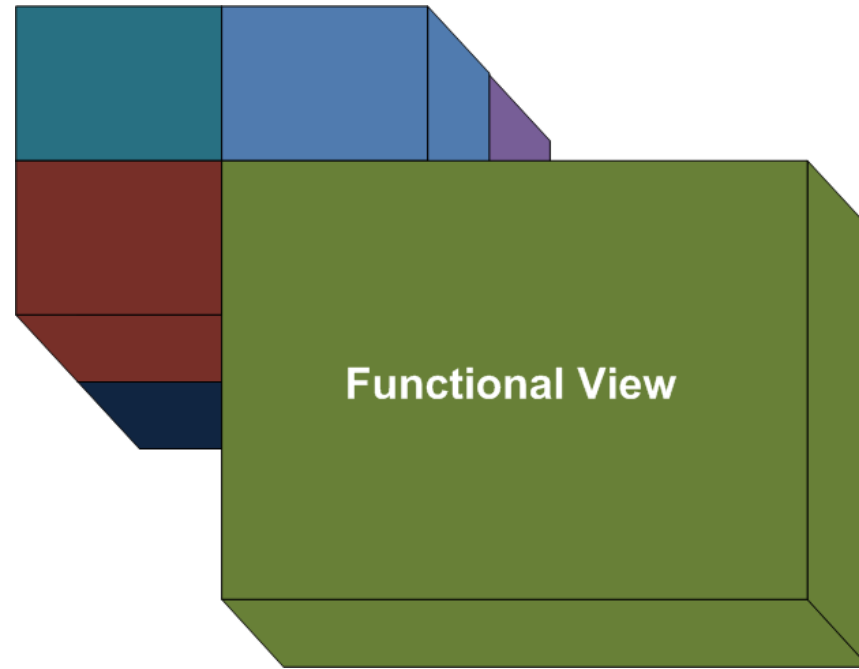

Architectural Views

FUNCTIONAL VIEWS

Portal Architecture

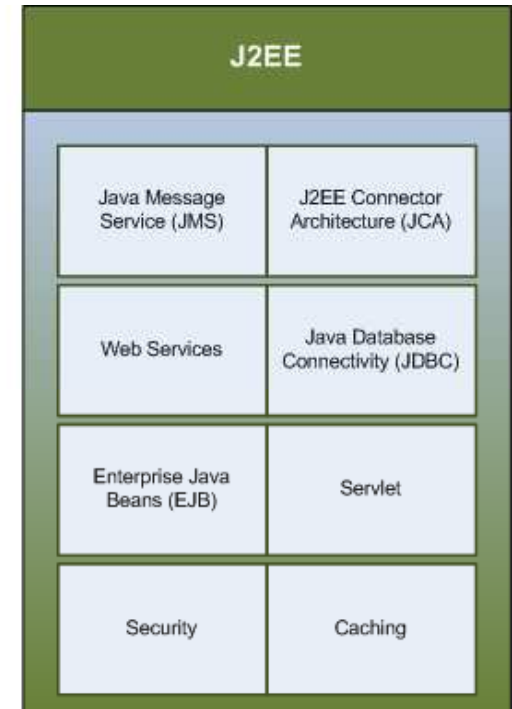
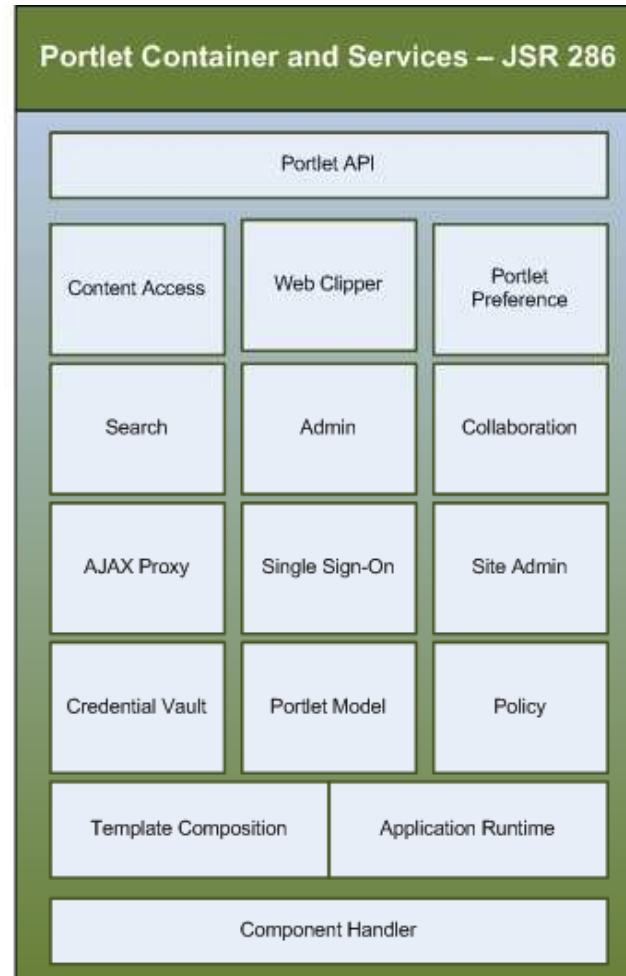
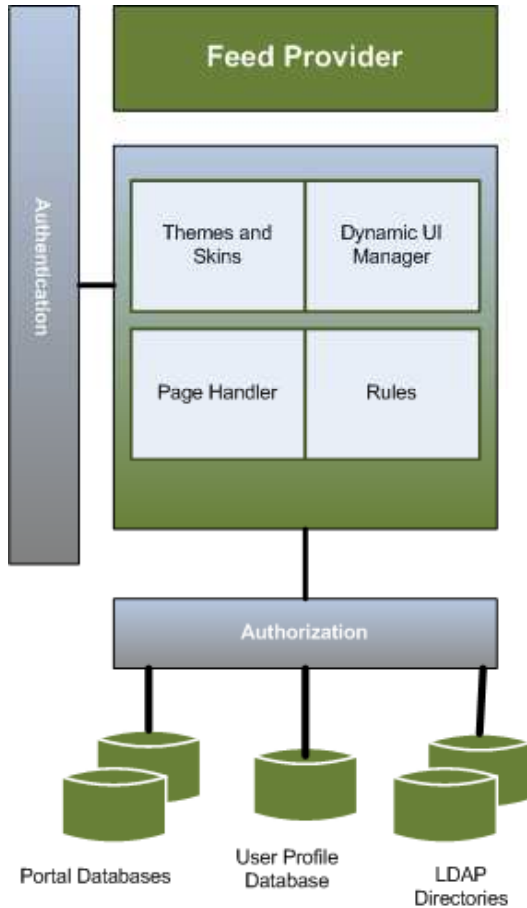
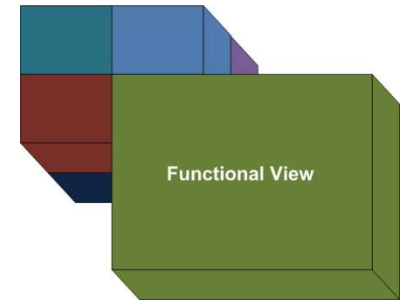

Web Content Management Architecture

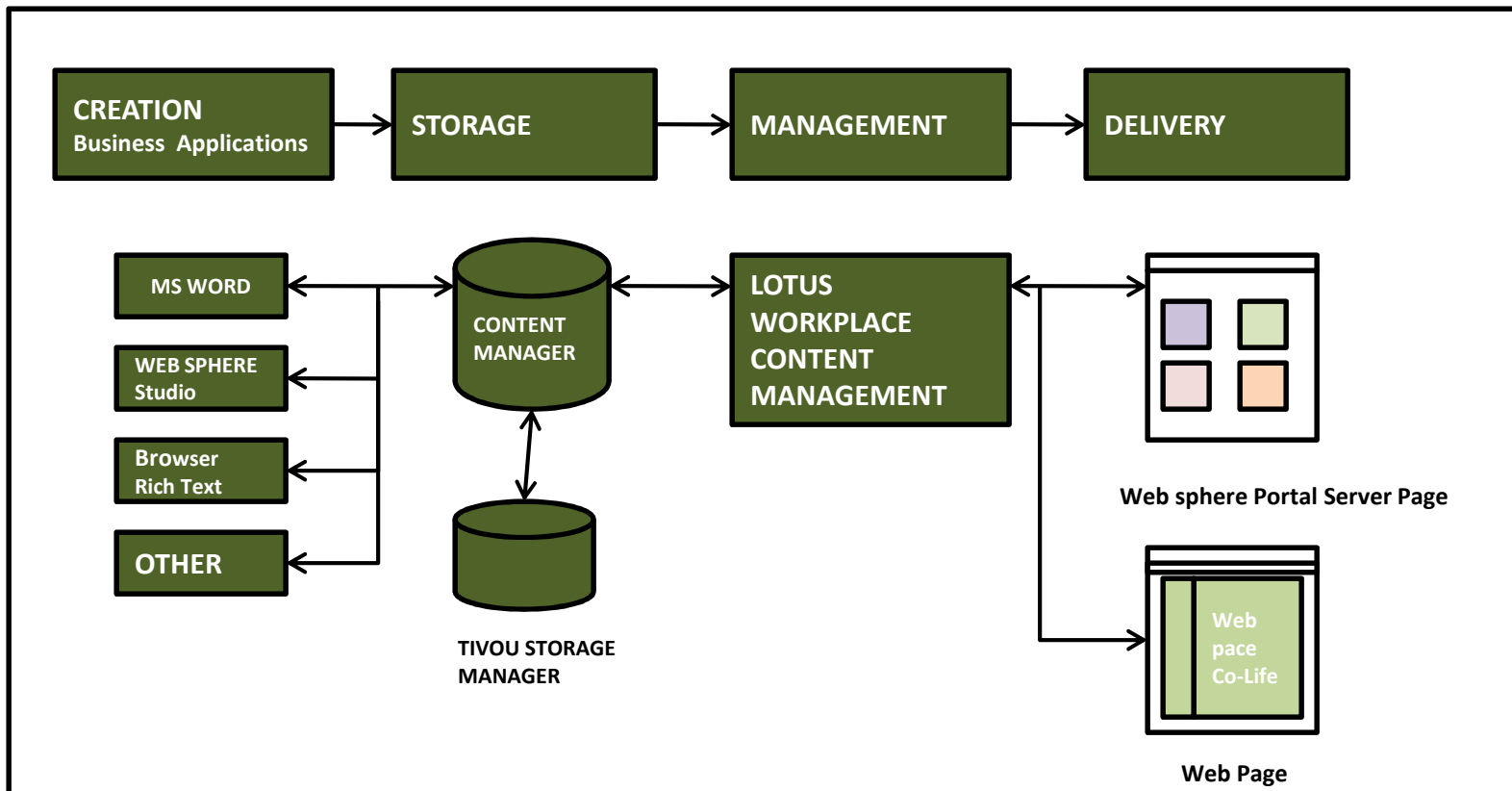
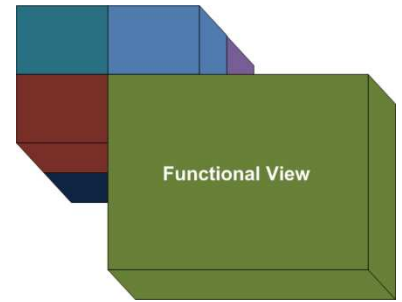

Portal and Content Management

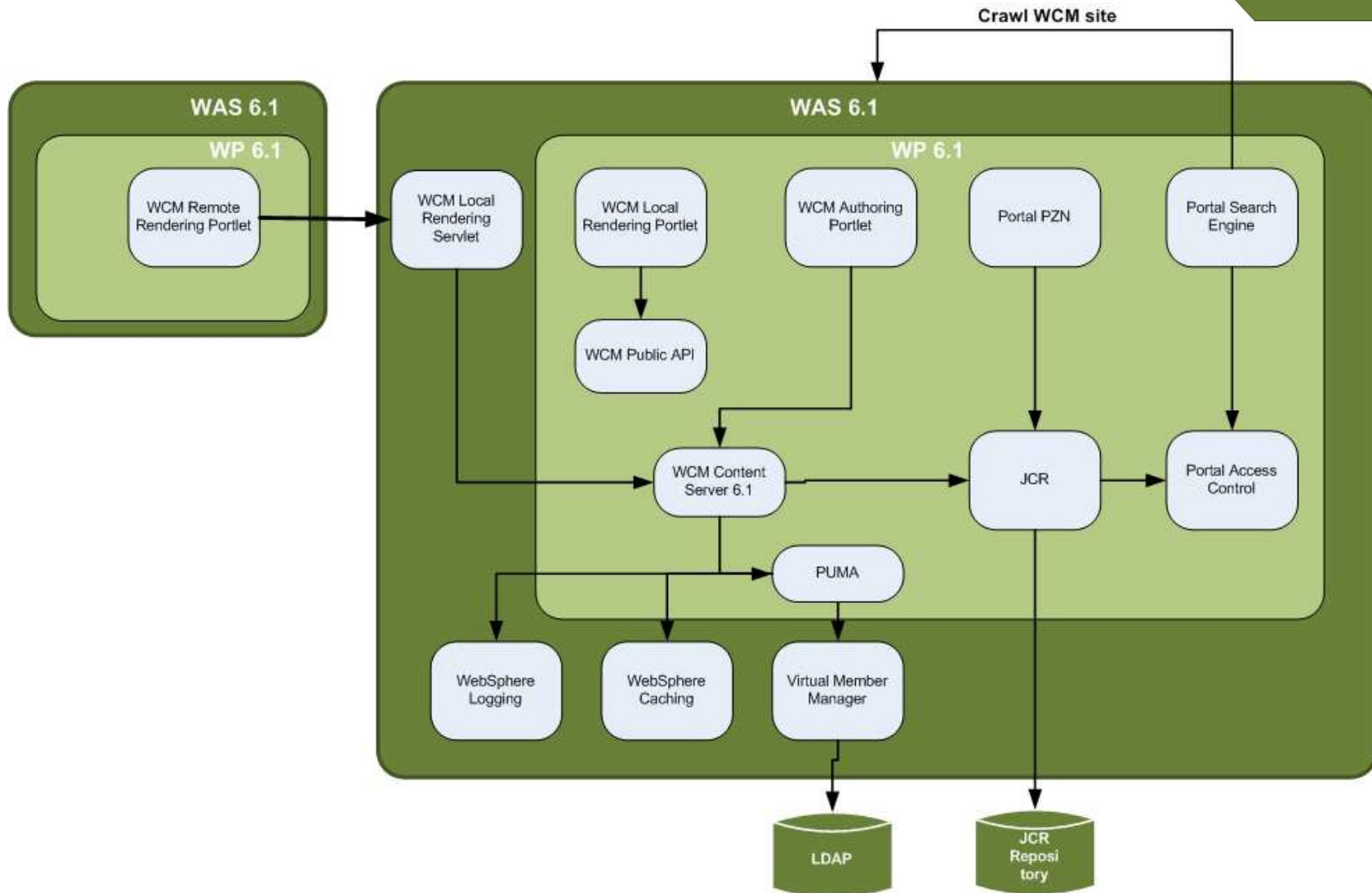
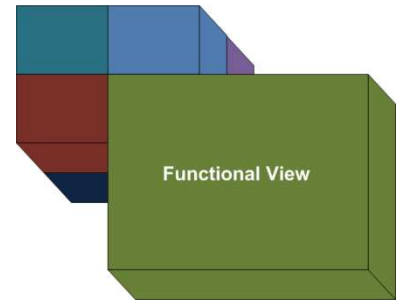

Content Search

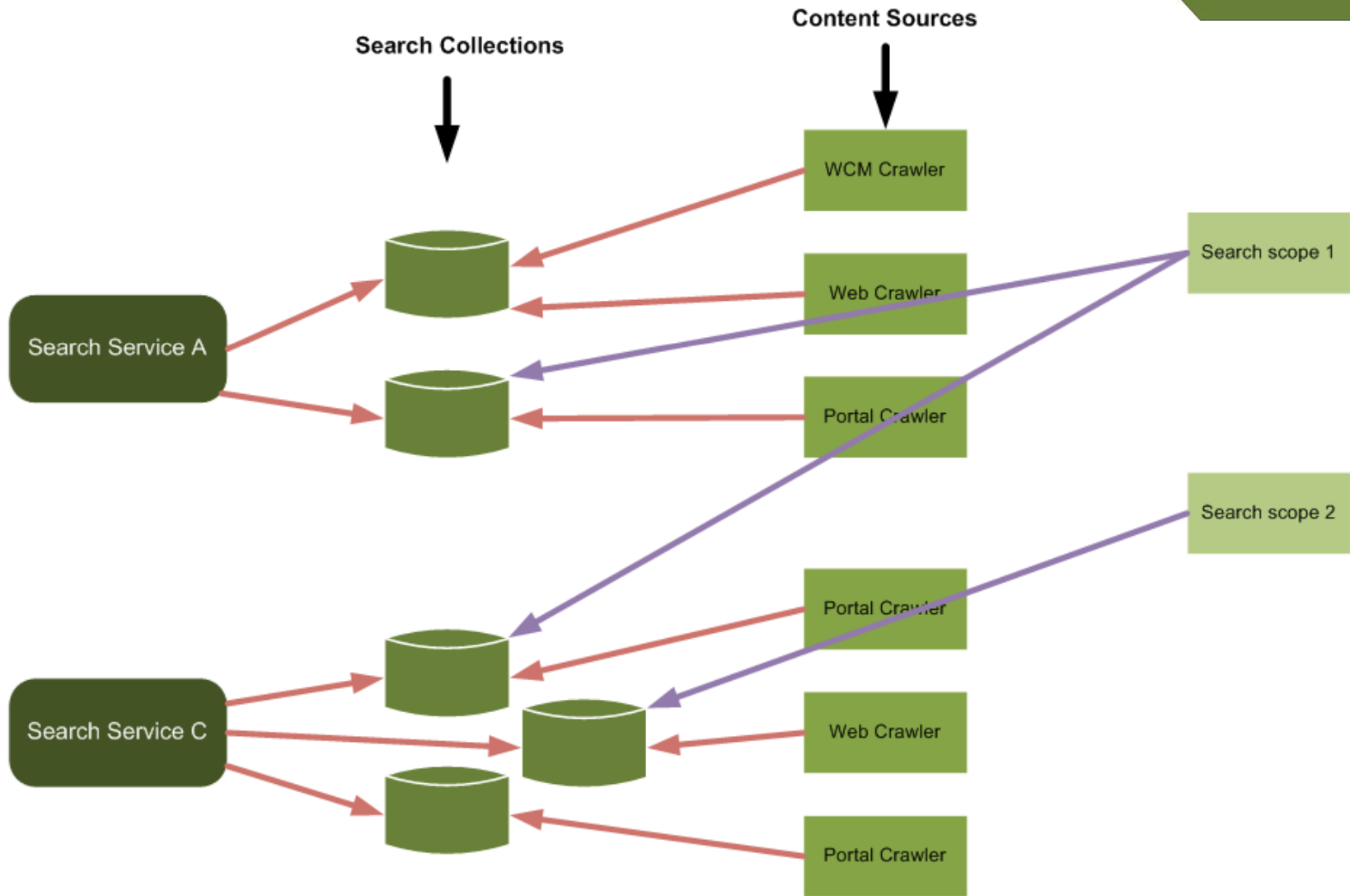
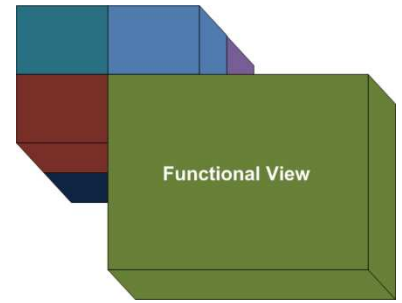

Portal Client Side Aggregation

Client-side Aggregation

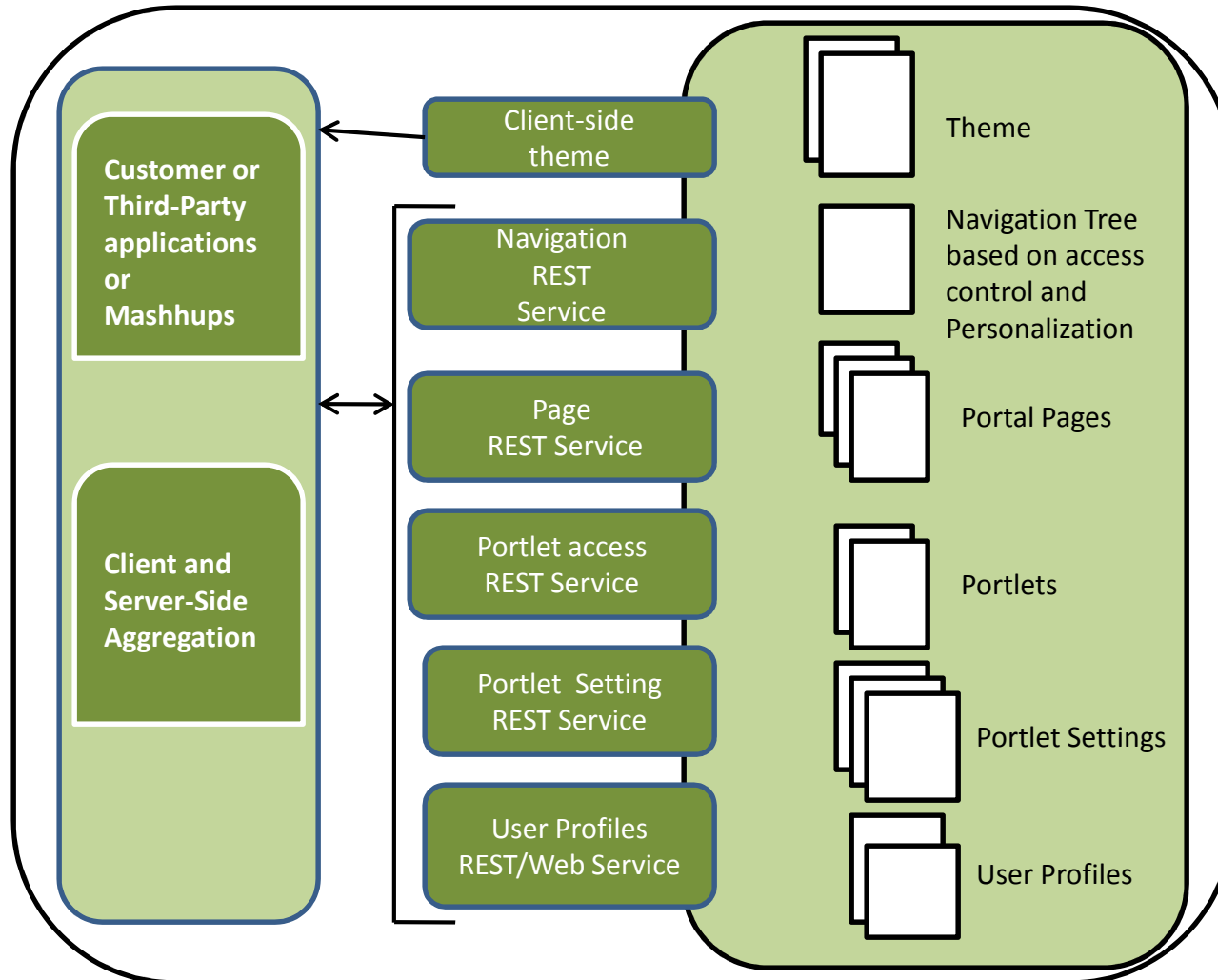
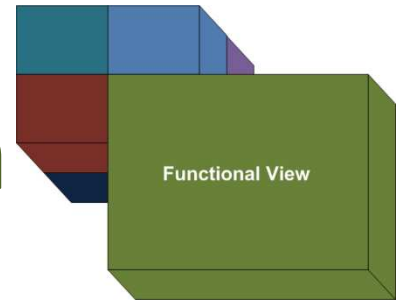

Mobile Support

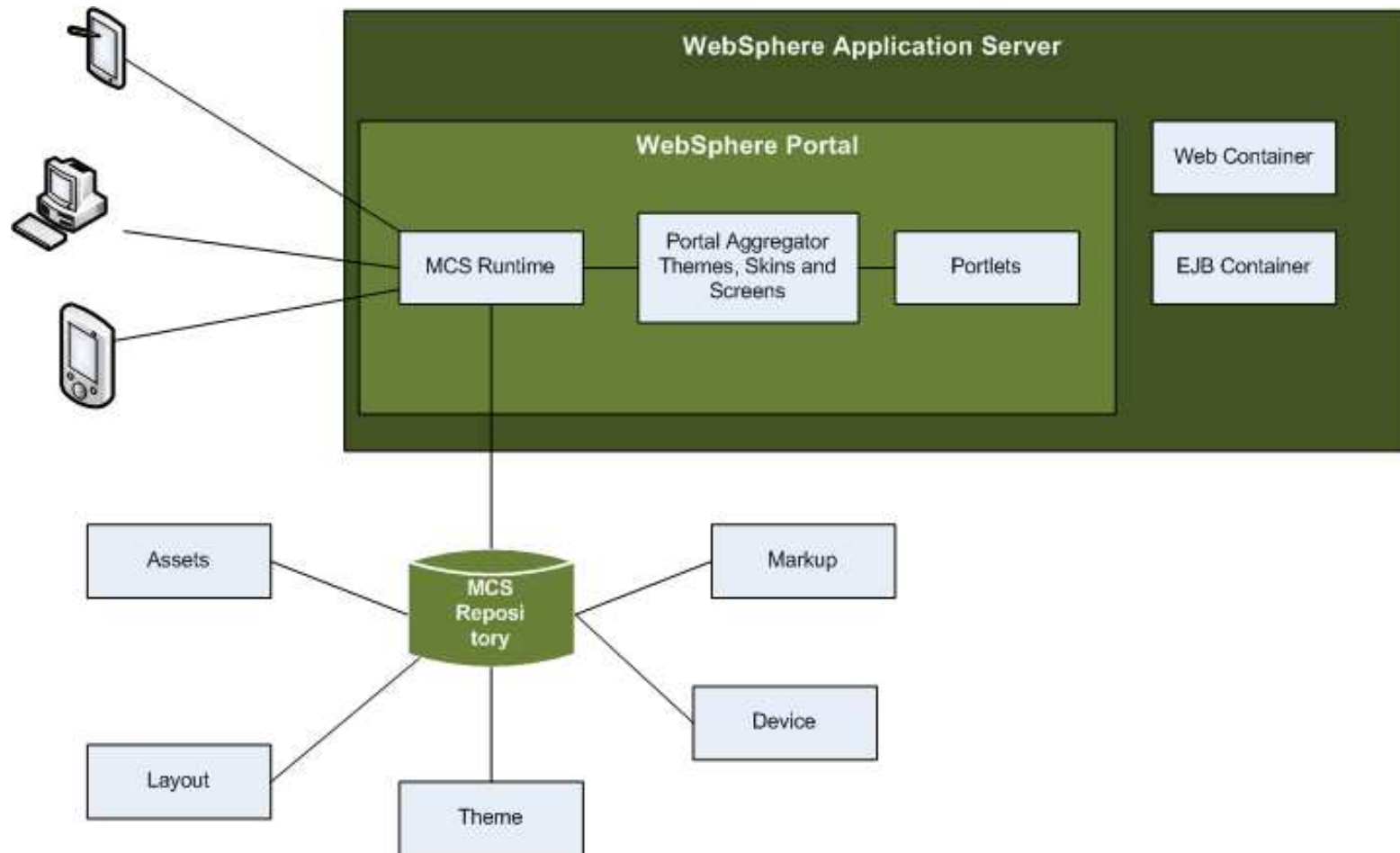
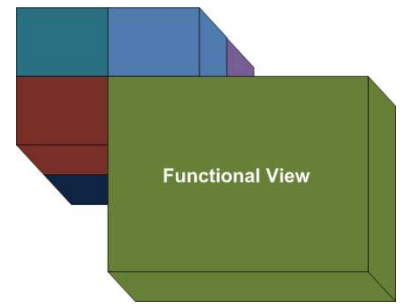

Mobile Support (contd ...)

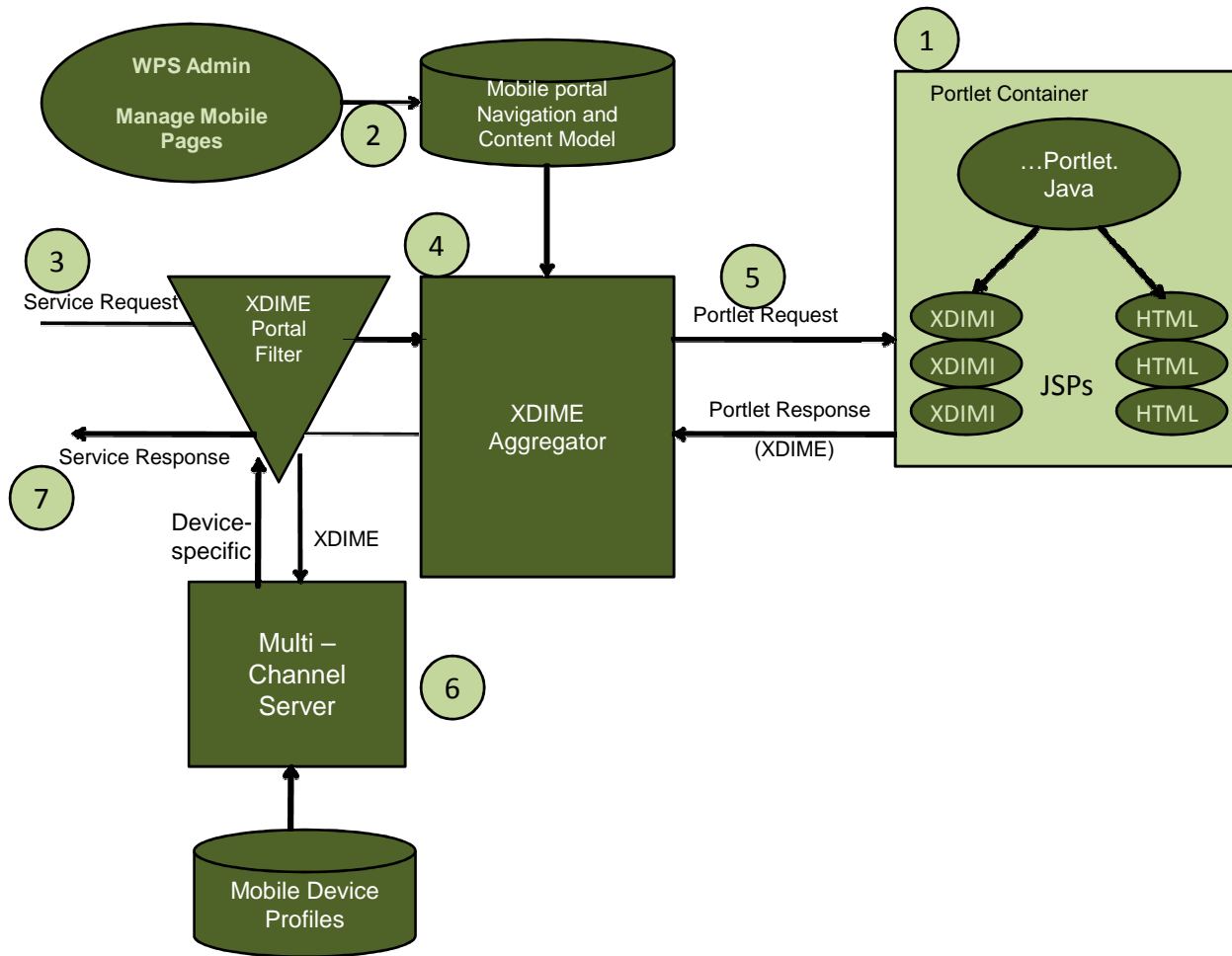
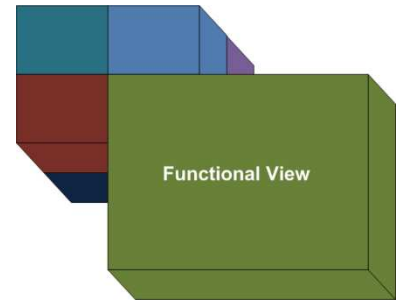

Portal Personalization

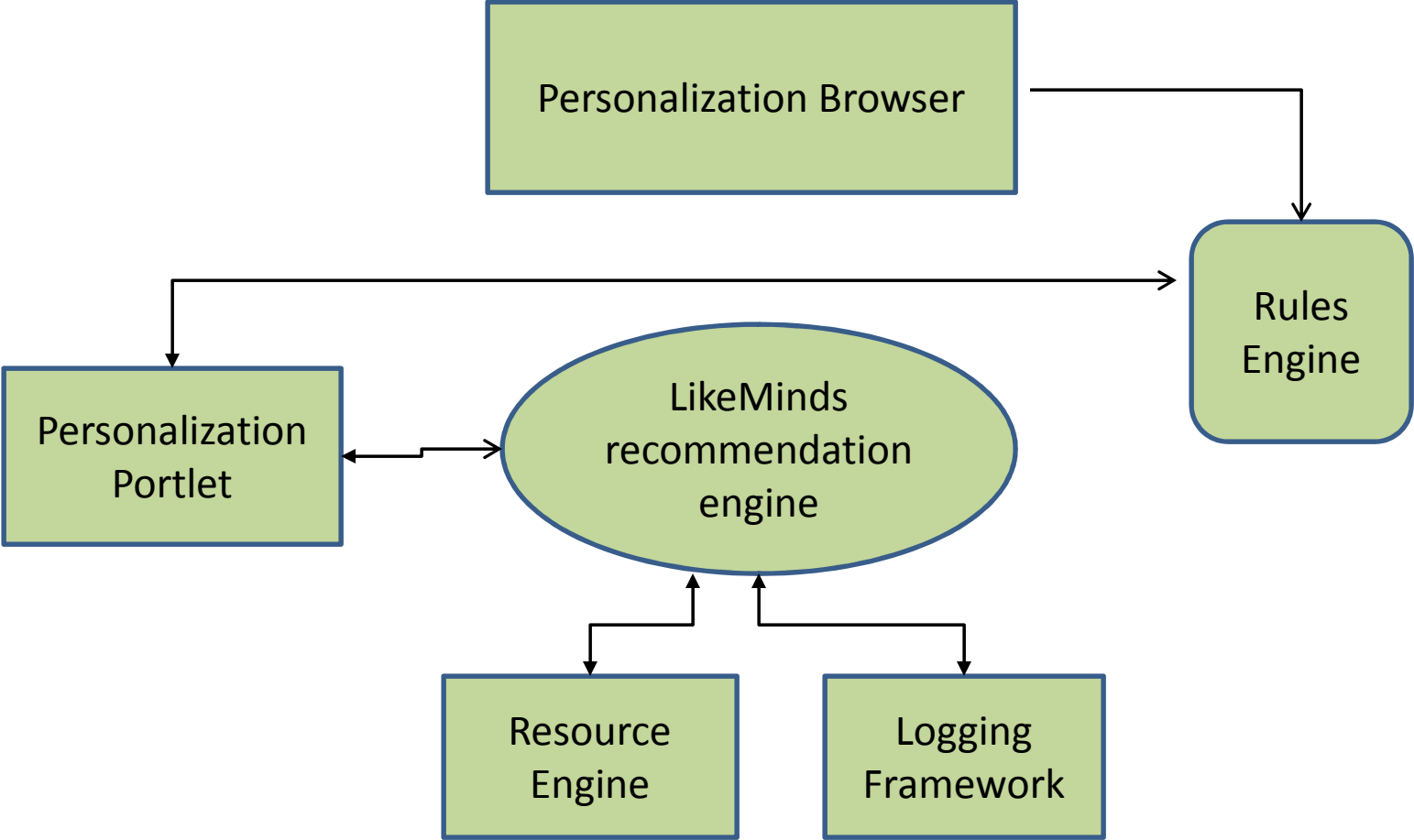
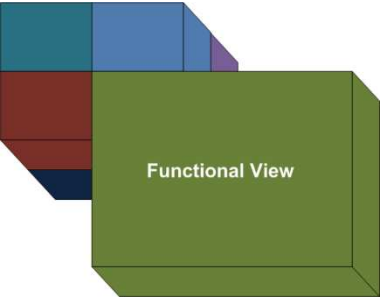

Rich Media Streaming

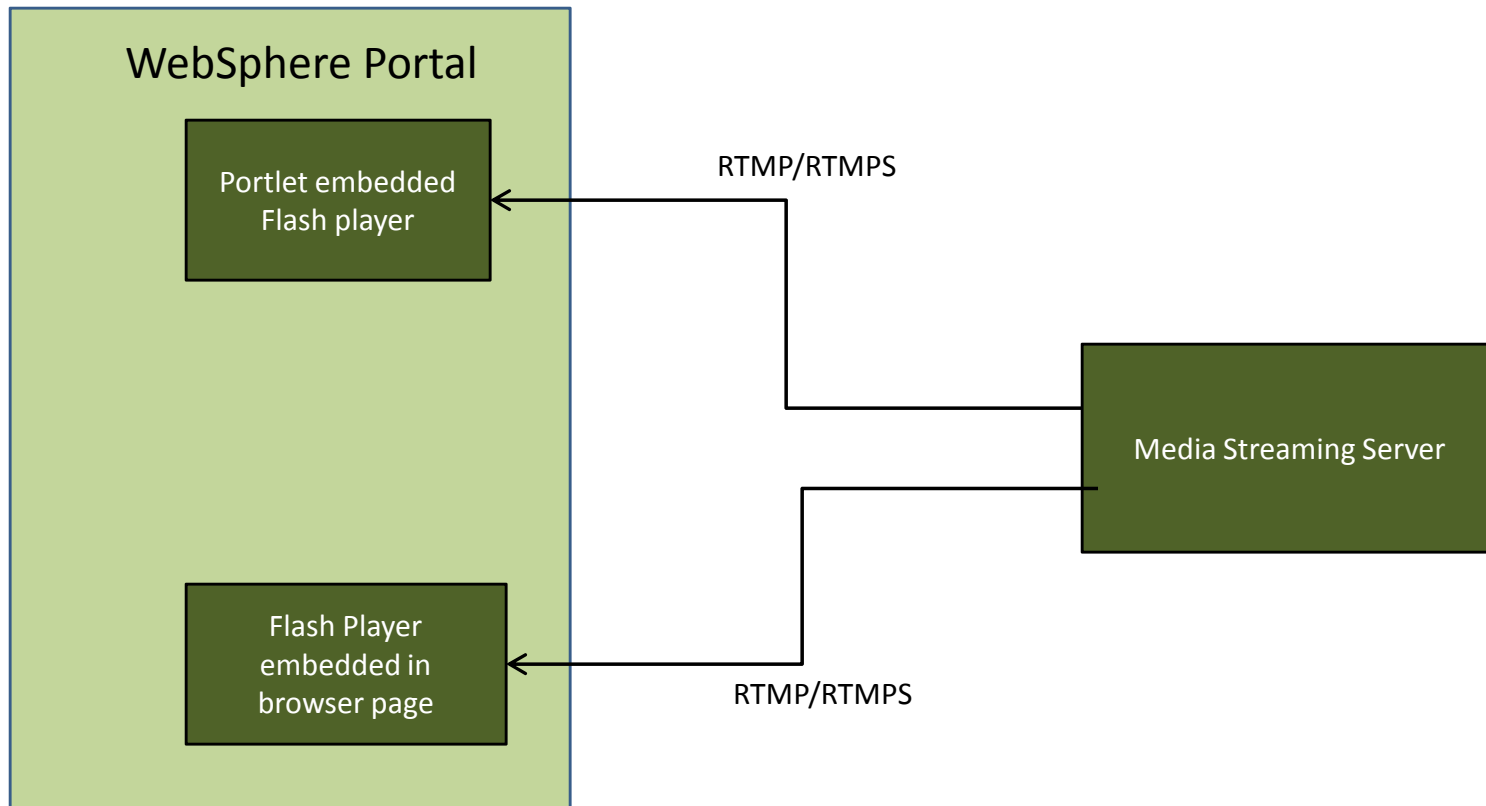
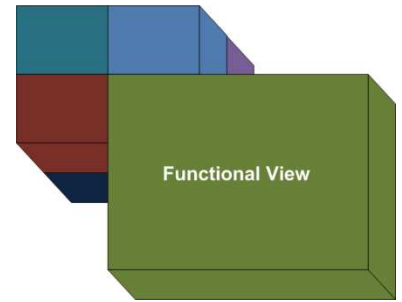

Content Caching

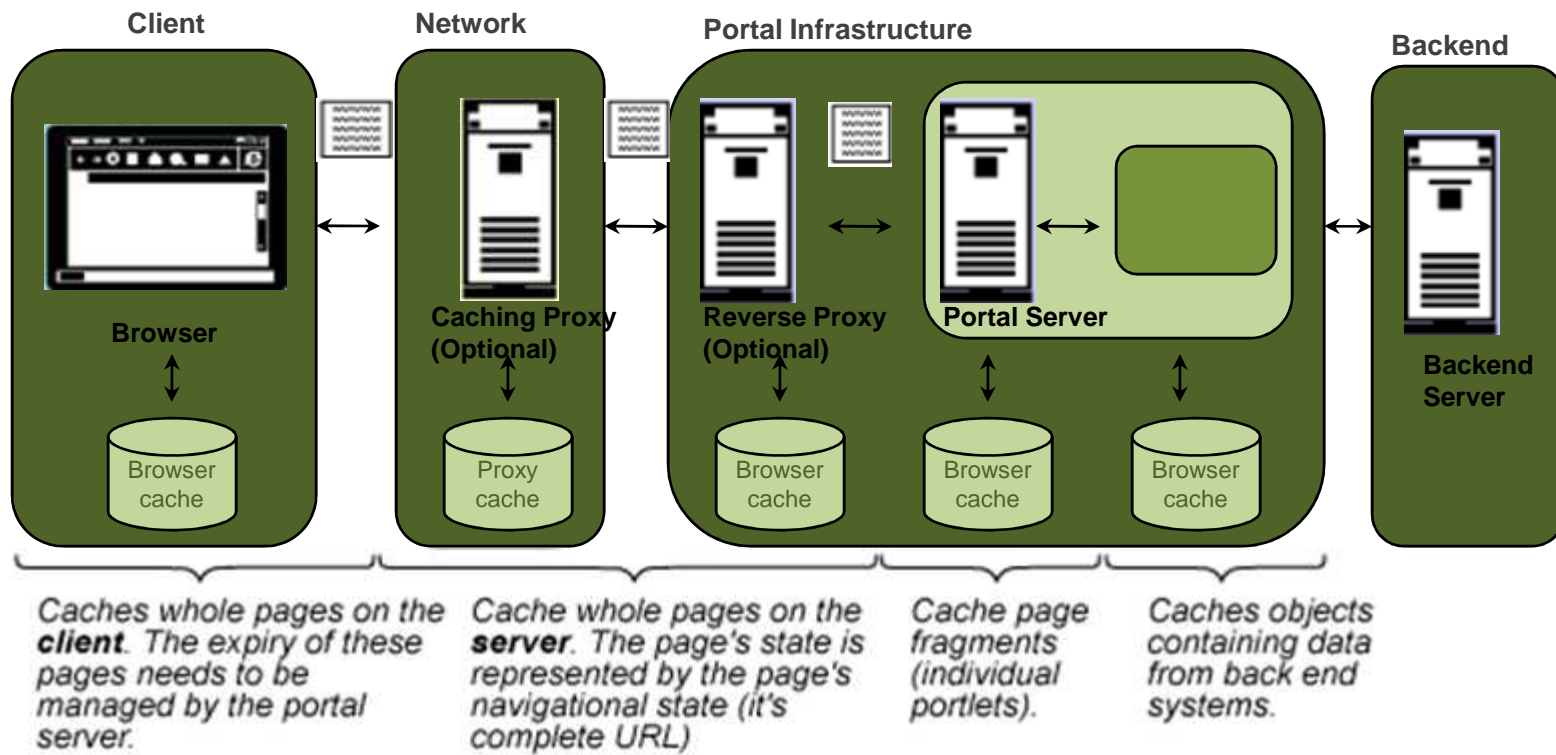
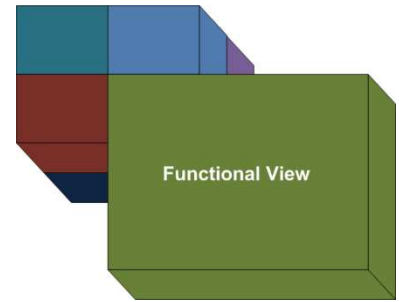

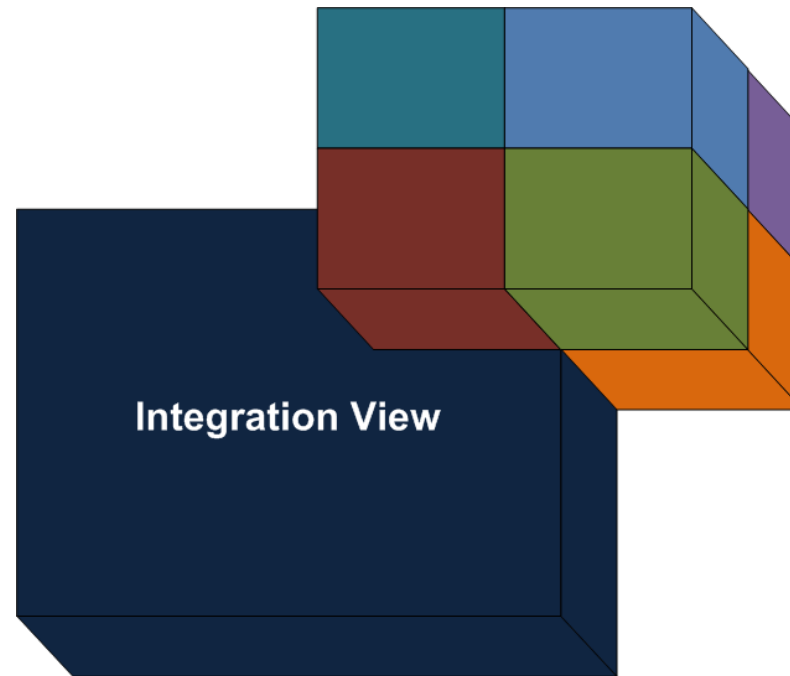

Architectural Views

INTEGRATION VIEWS

Integration Patterns

- Presentation Integration
- Programmatic Integration
- Middleware Integration

Content Integration Architecture

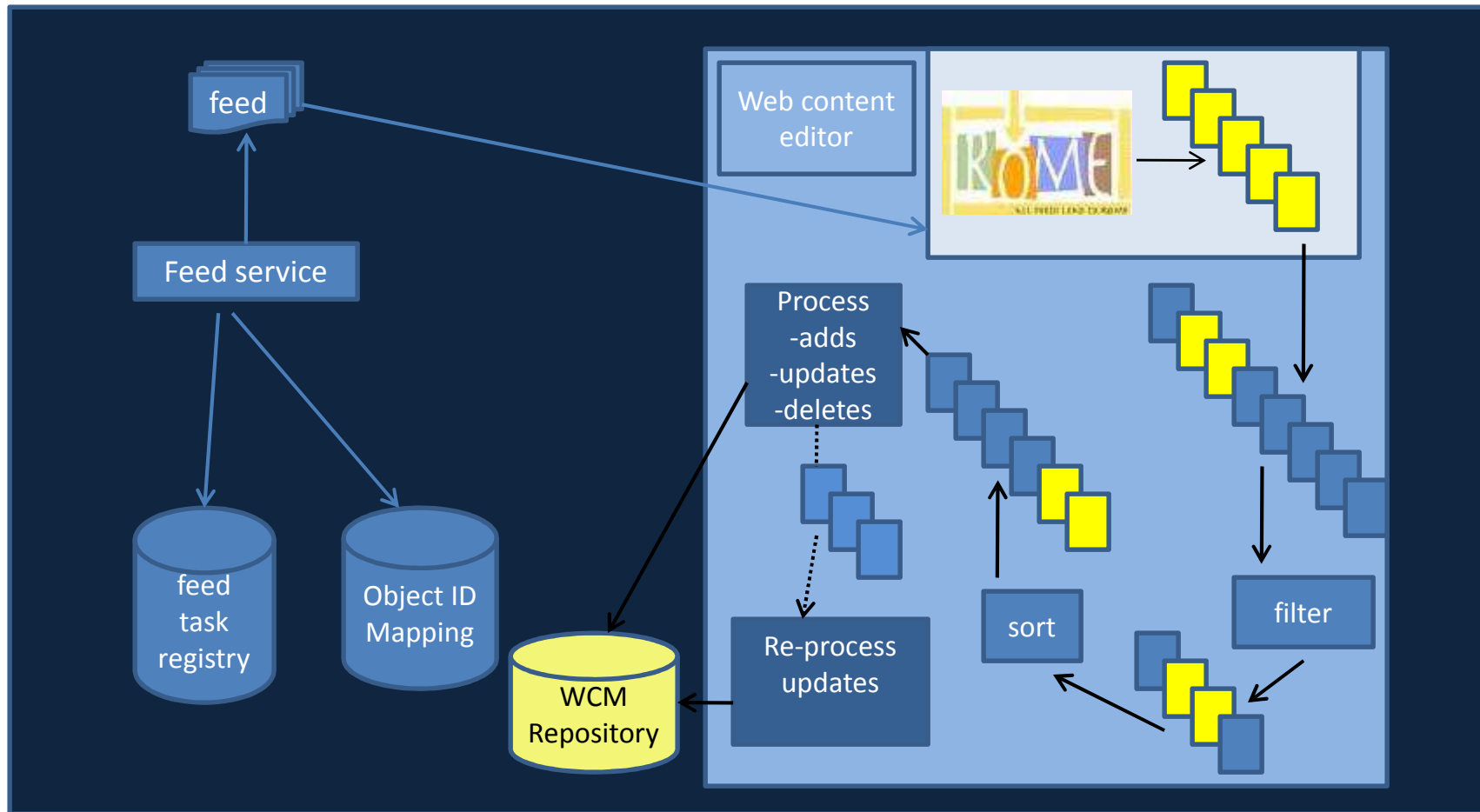
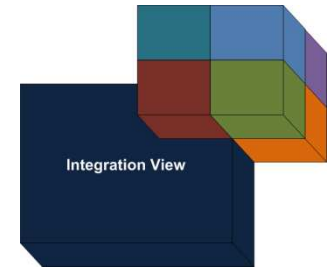

Application Integration Architecture

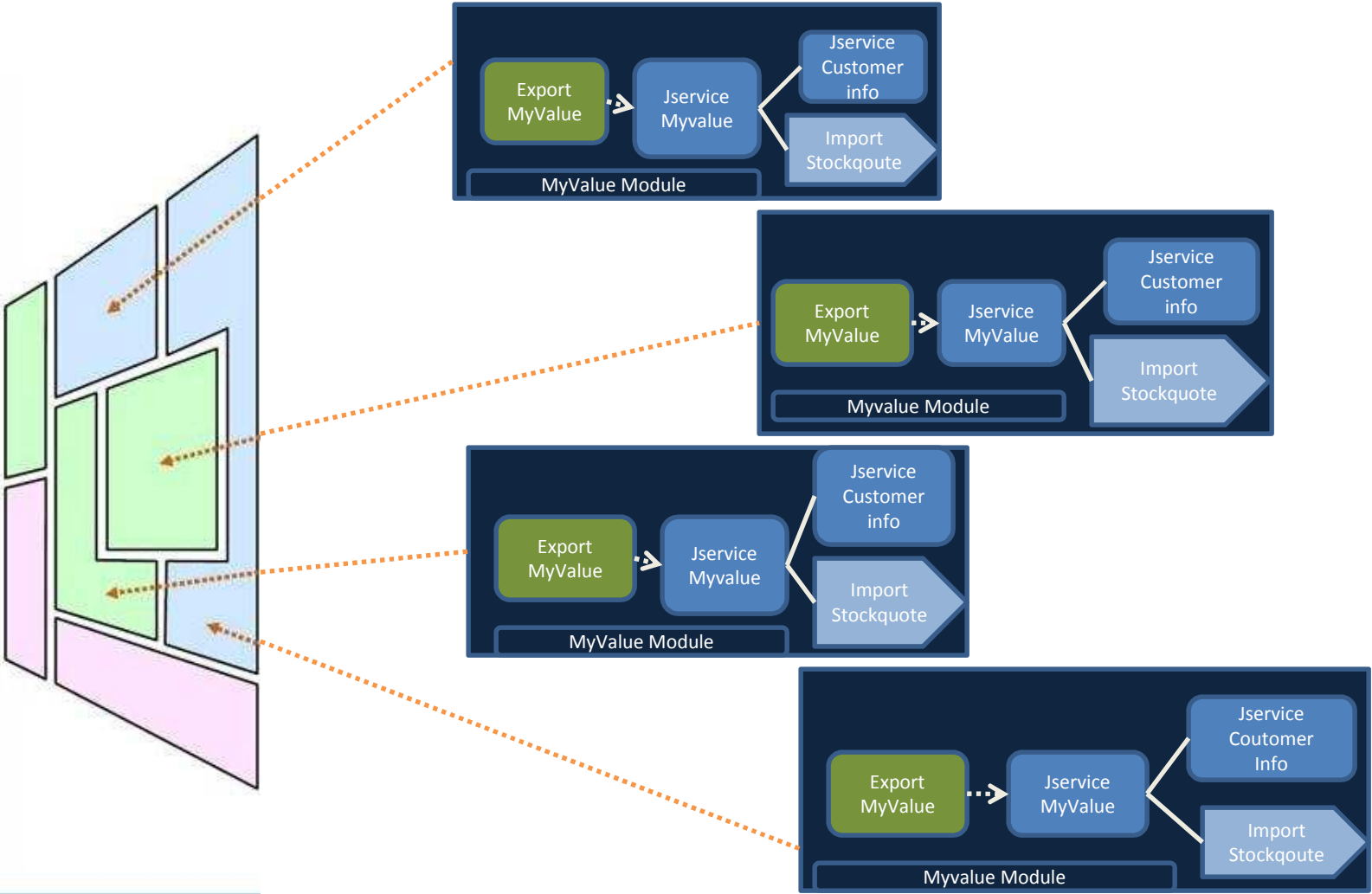

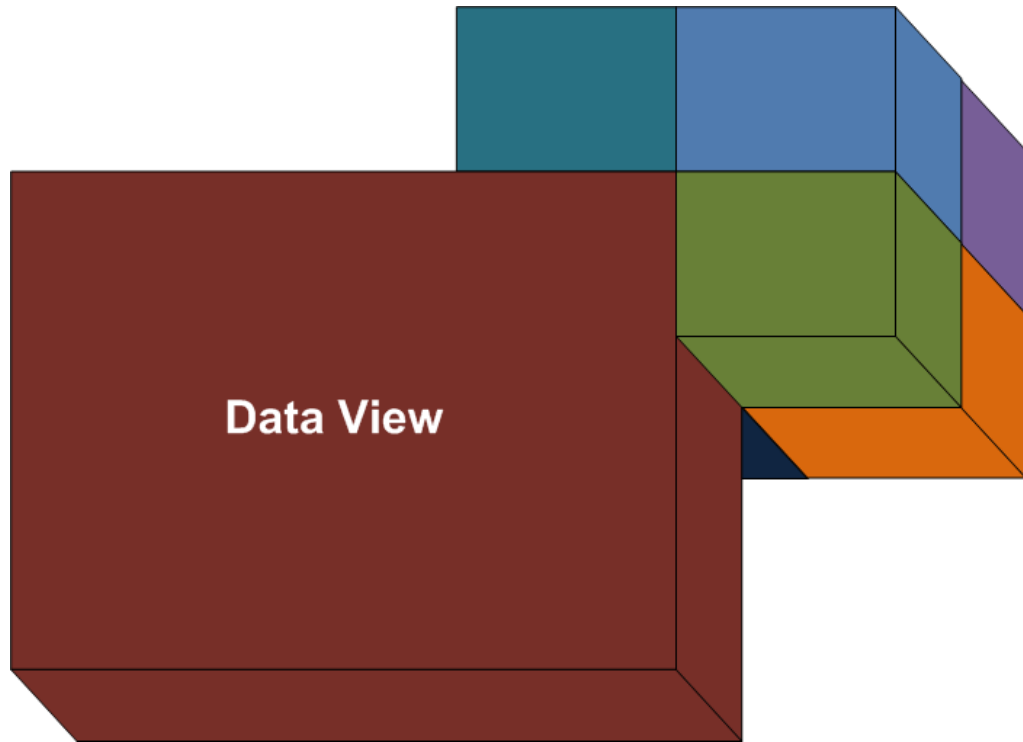

Architectural Views

DATA VIEWS

Data Flow Diagram – Unsecured Content Access

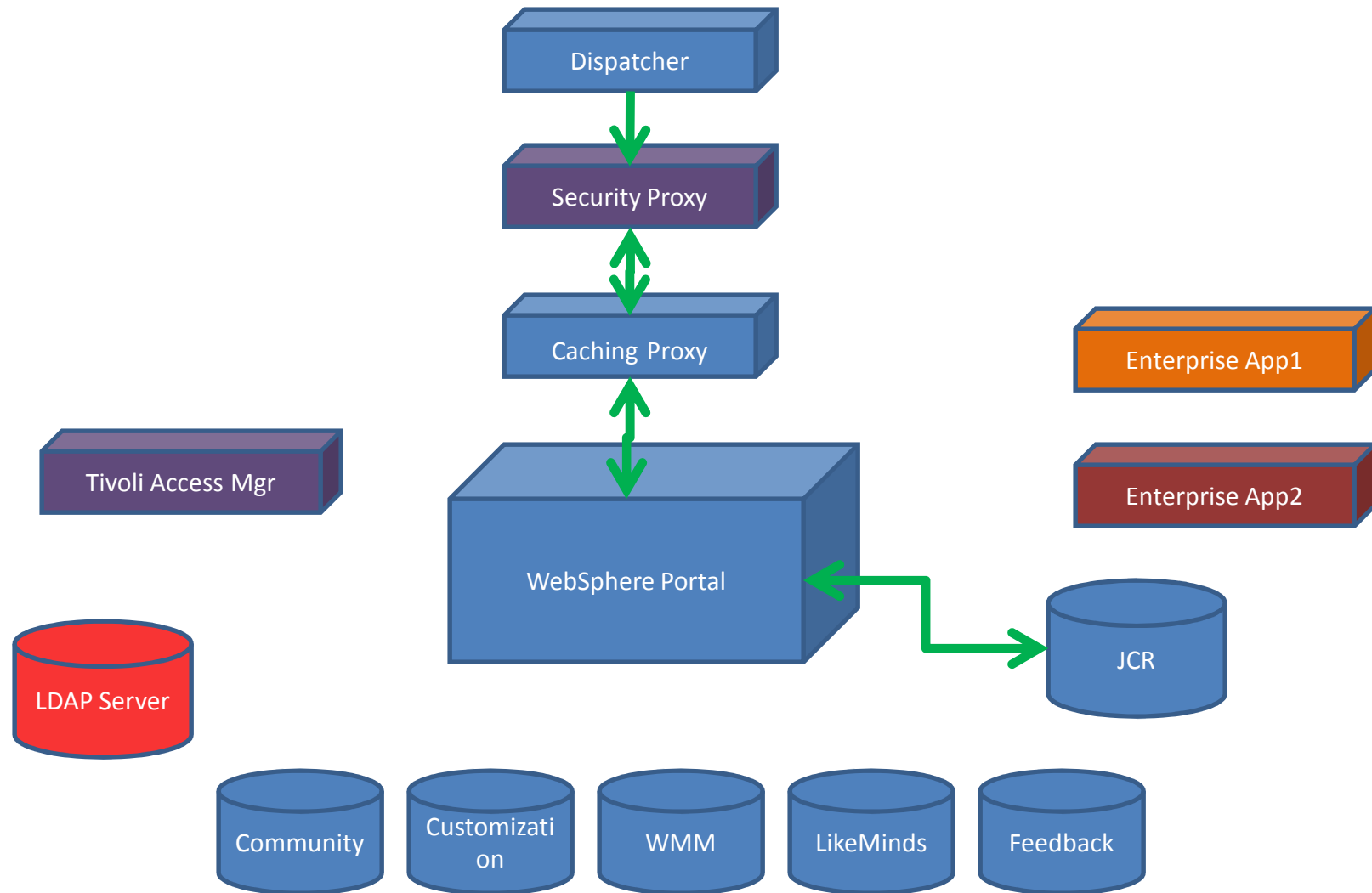
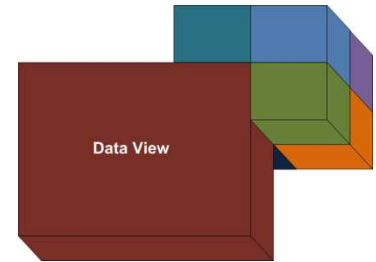

Data Flow Diagram – Secured Content Access

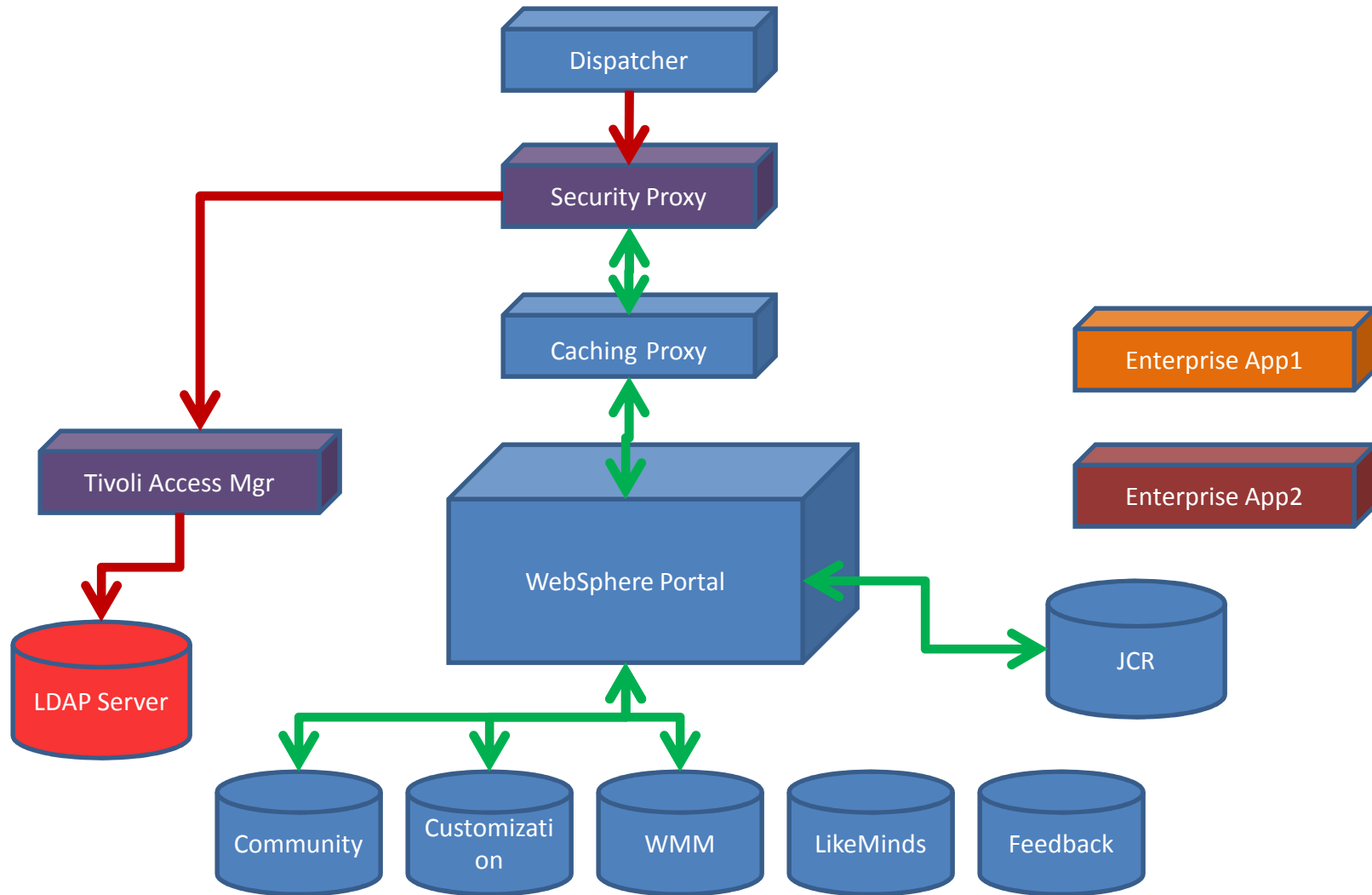
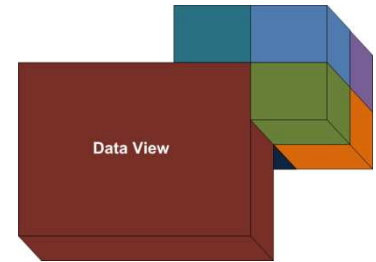

Data Flow Diagram – Transaction Services Access

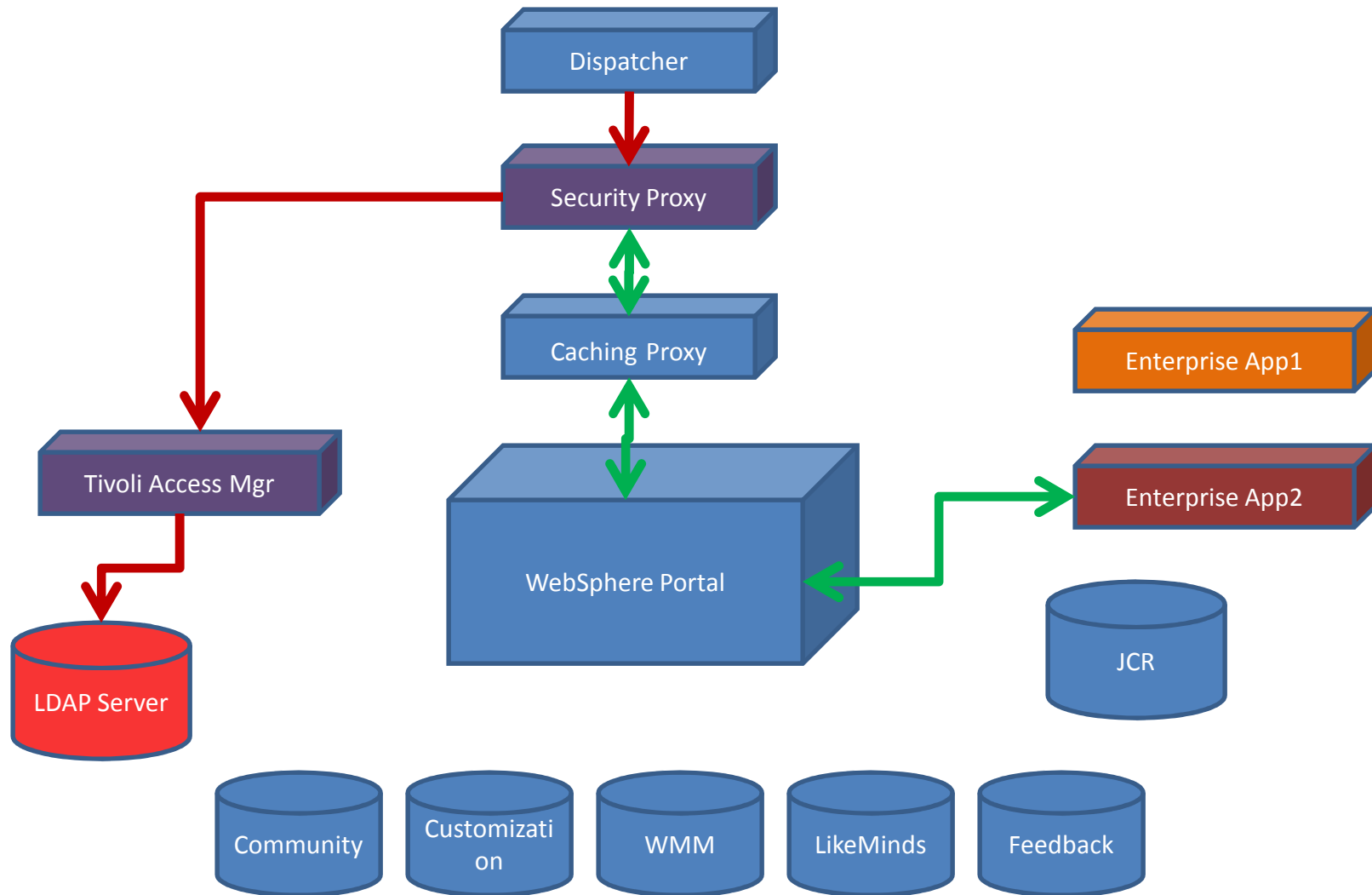
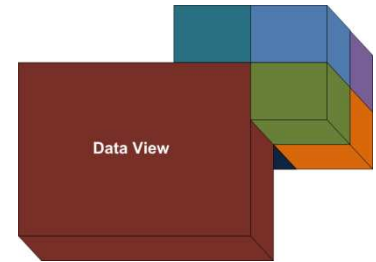

Data Flow Diagram – Streaming Content Access

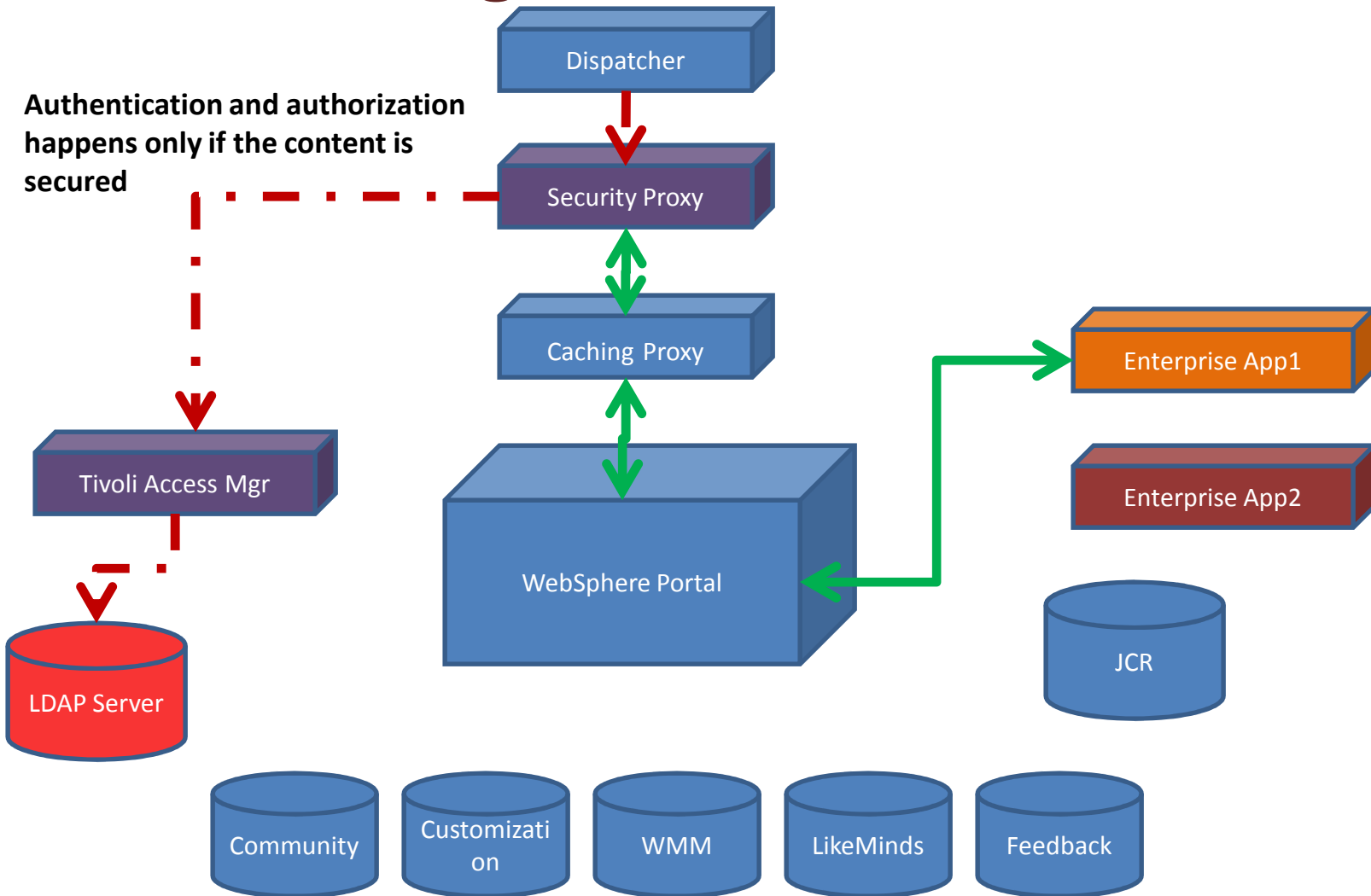
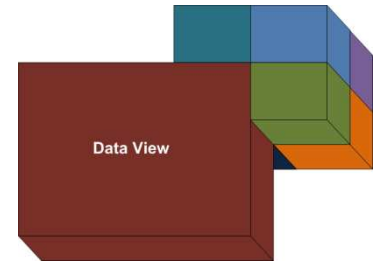

Data Flow Diagram – Personalized Content Access

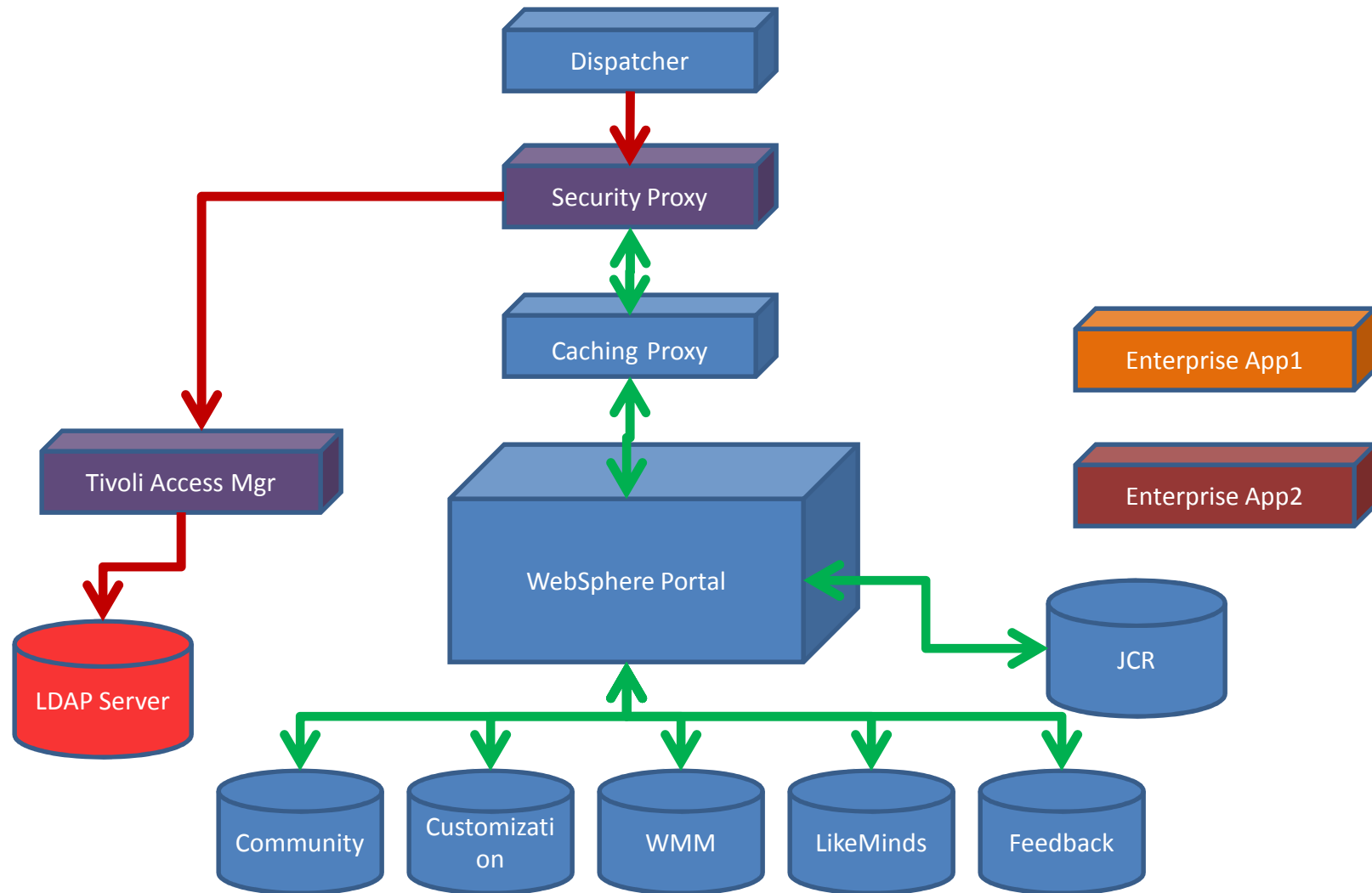
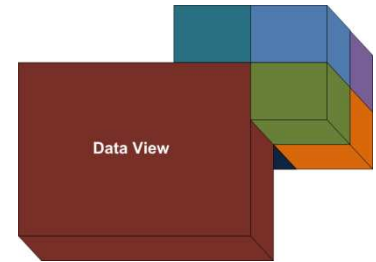

Resource View

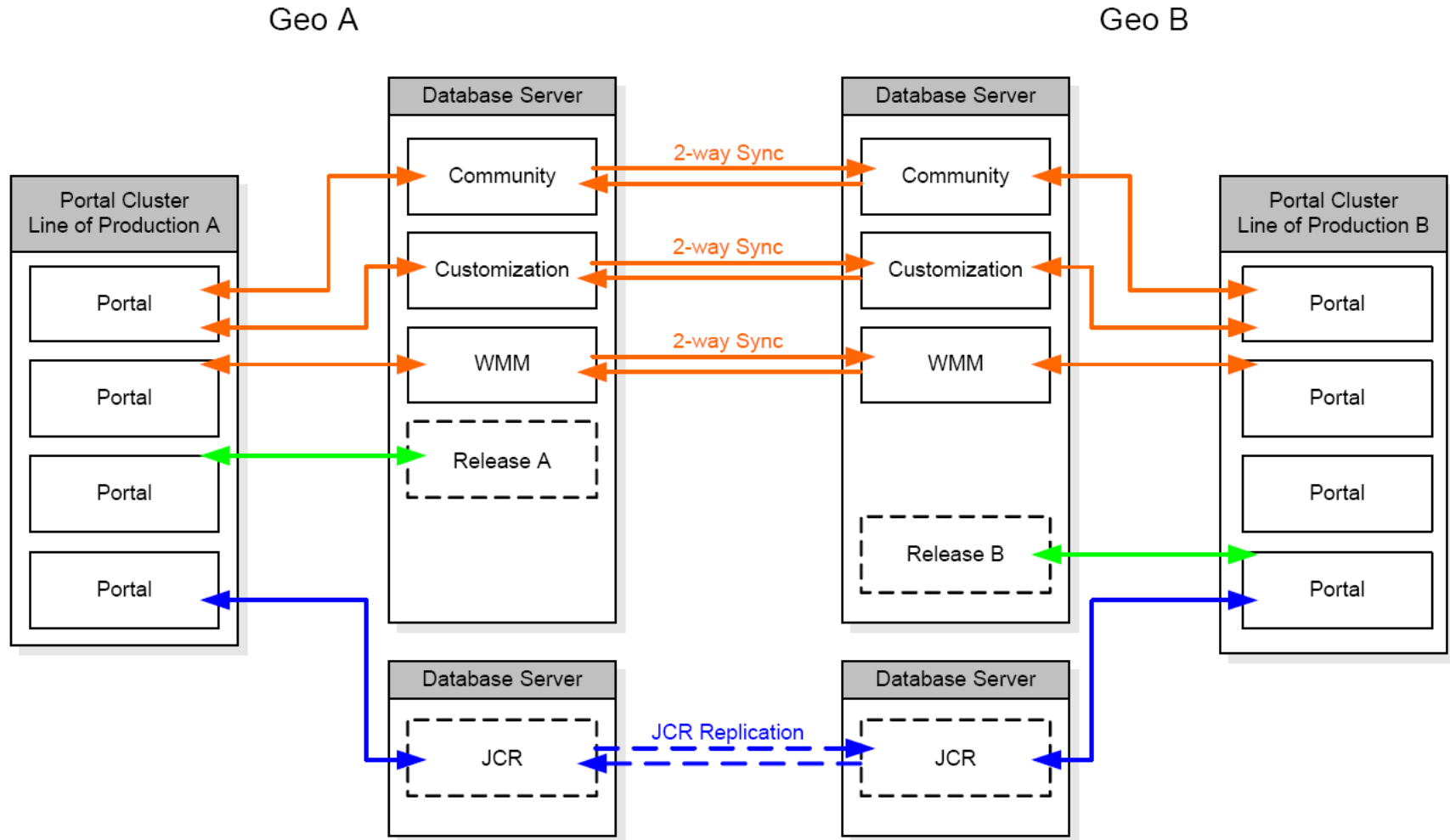
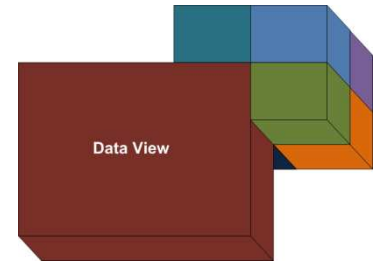

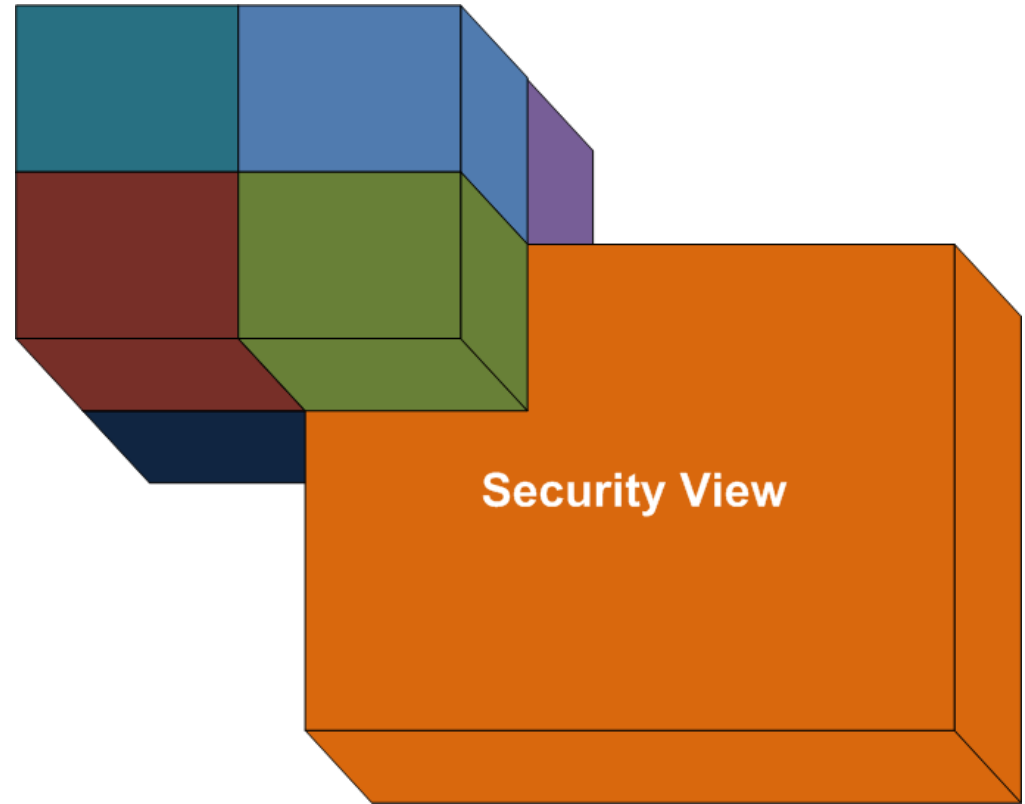

Architectural Views

SECURITY VIEWS

Component Security View

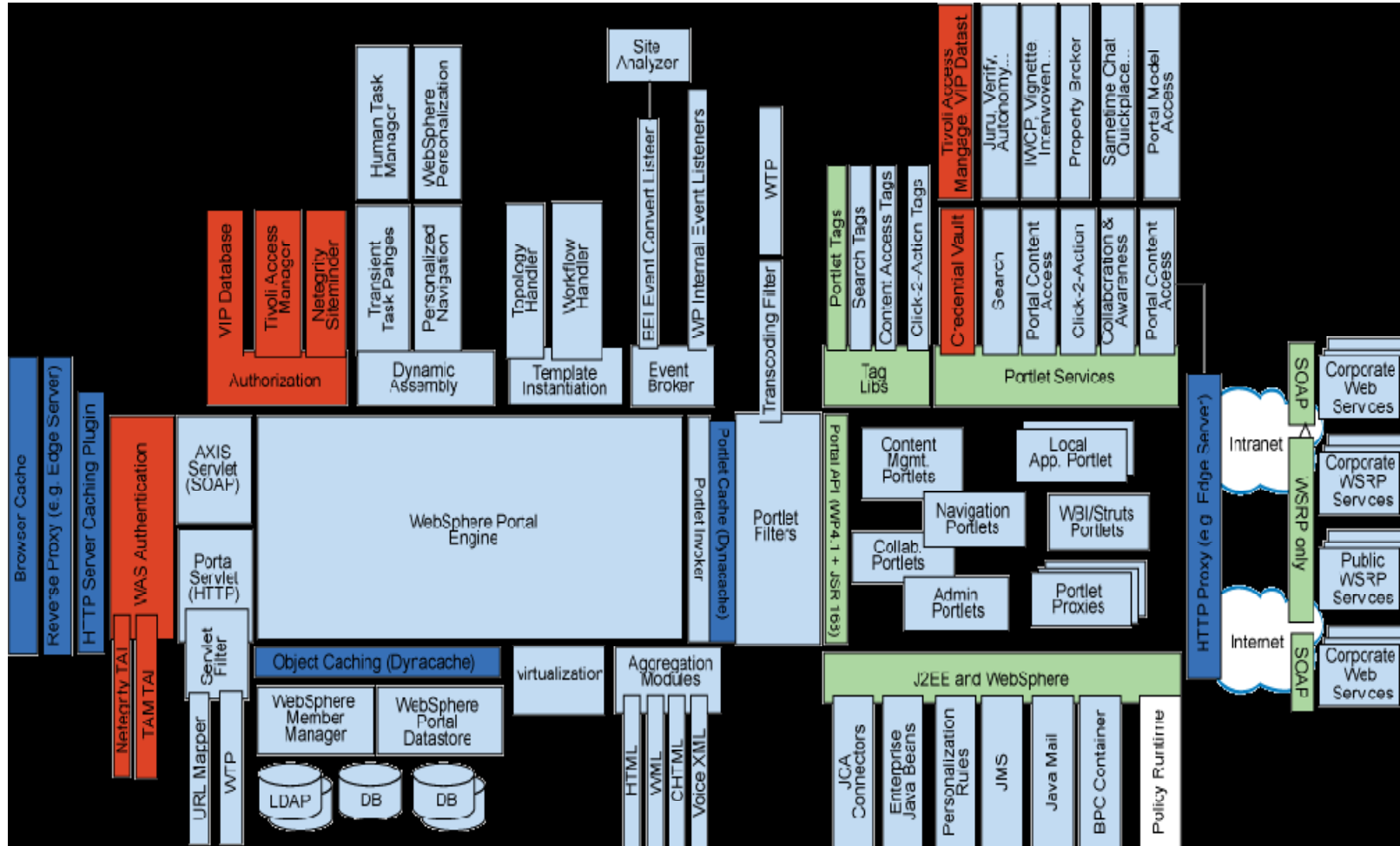
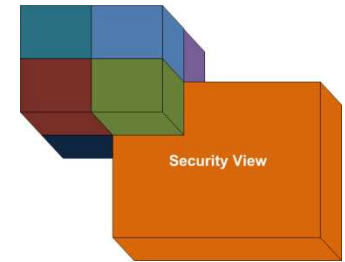

Intranet Perimeter Security

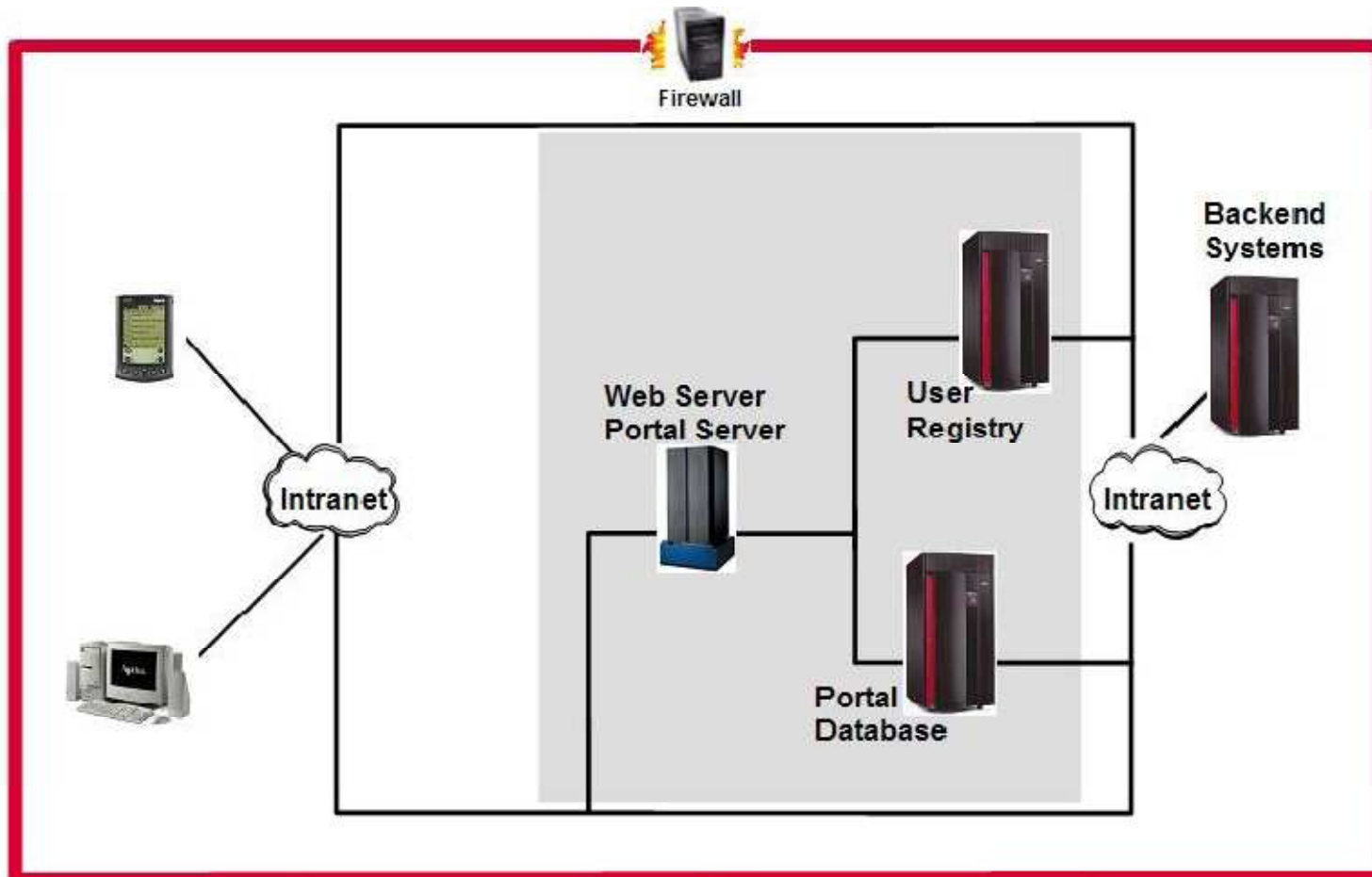
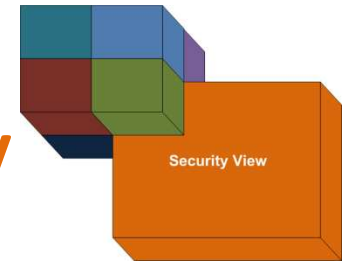

Internet Perimeter Security

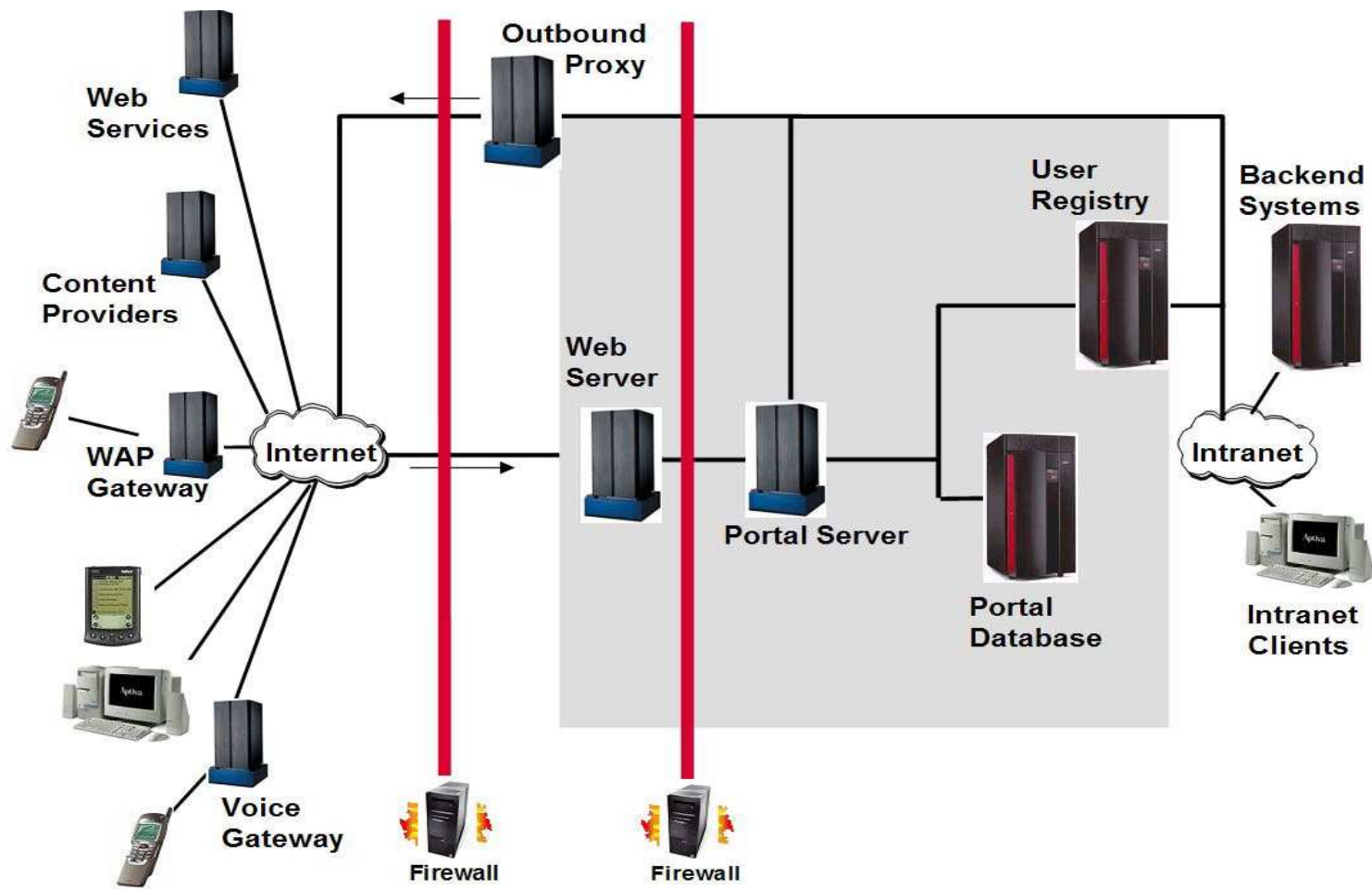
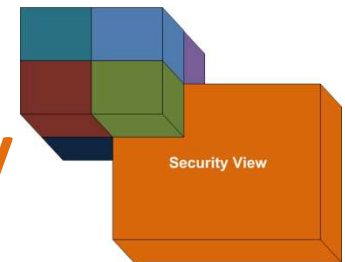

Security Policy View

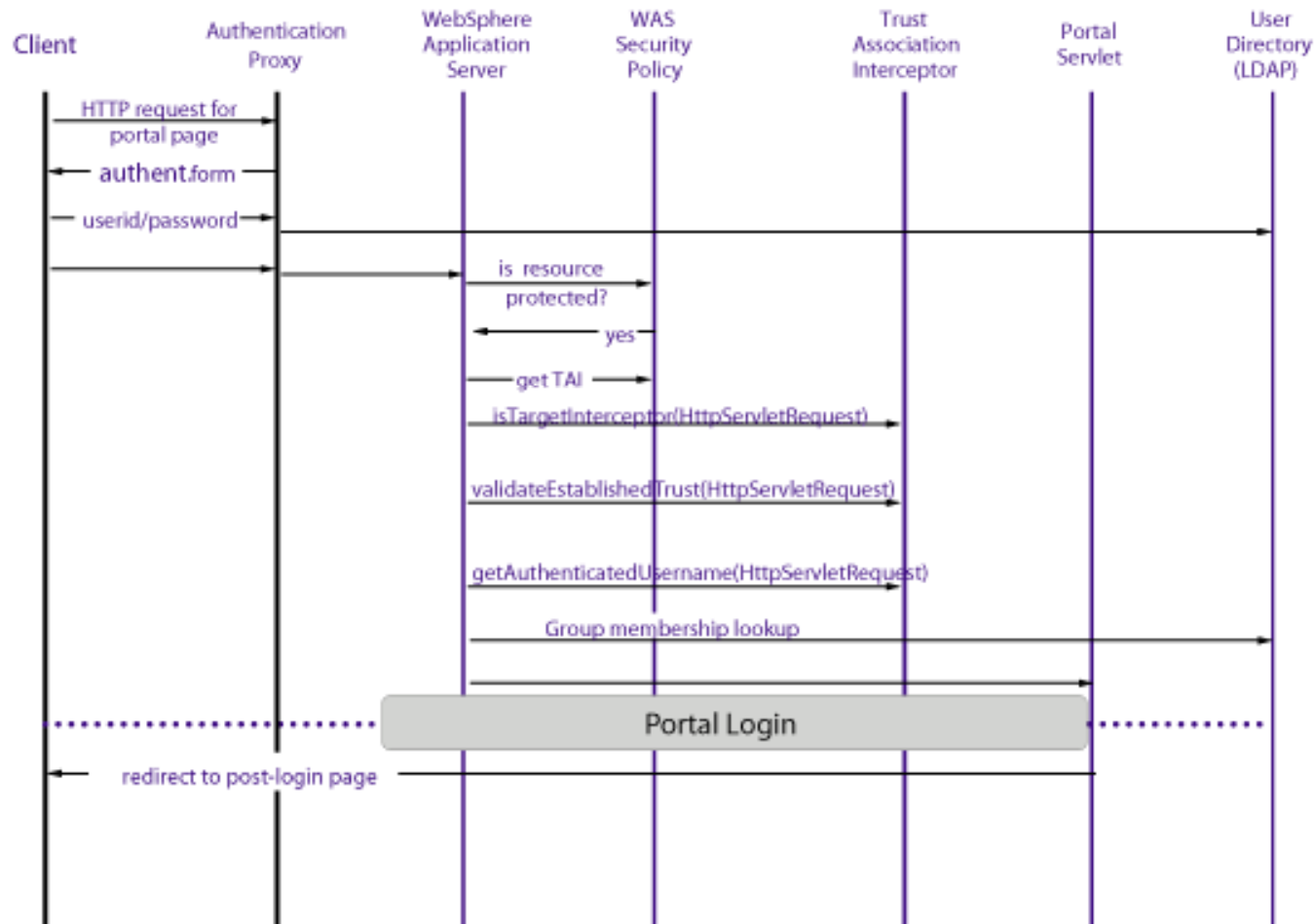
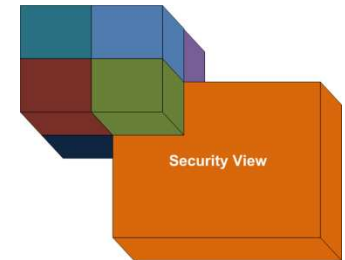

Single Sign-On

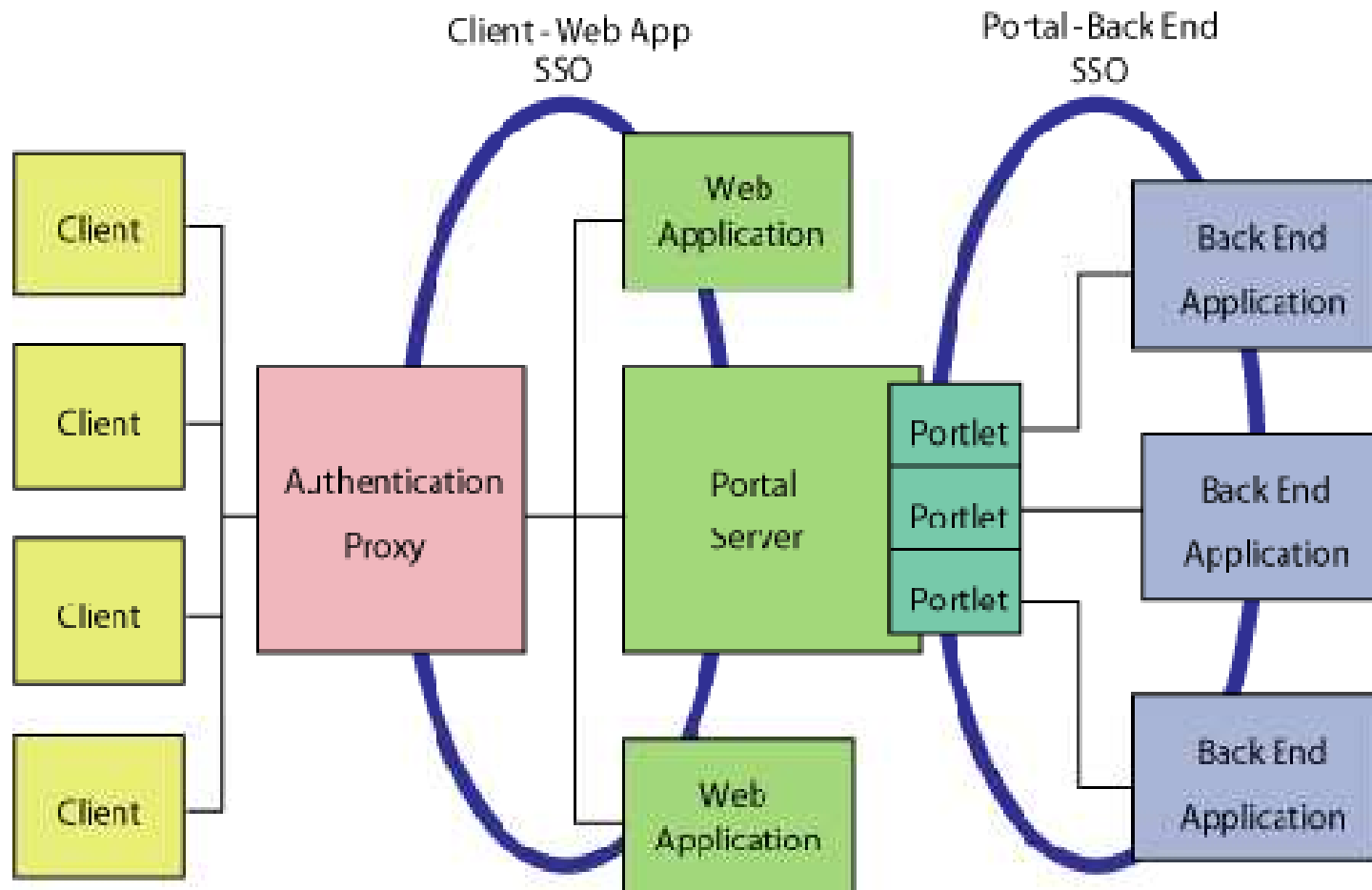
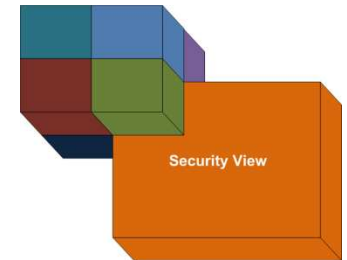

Transport Level Security

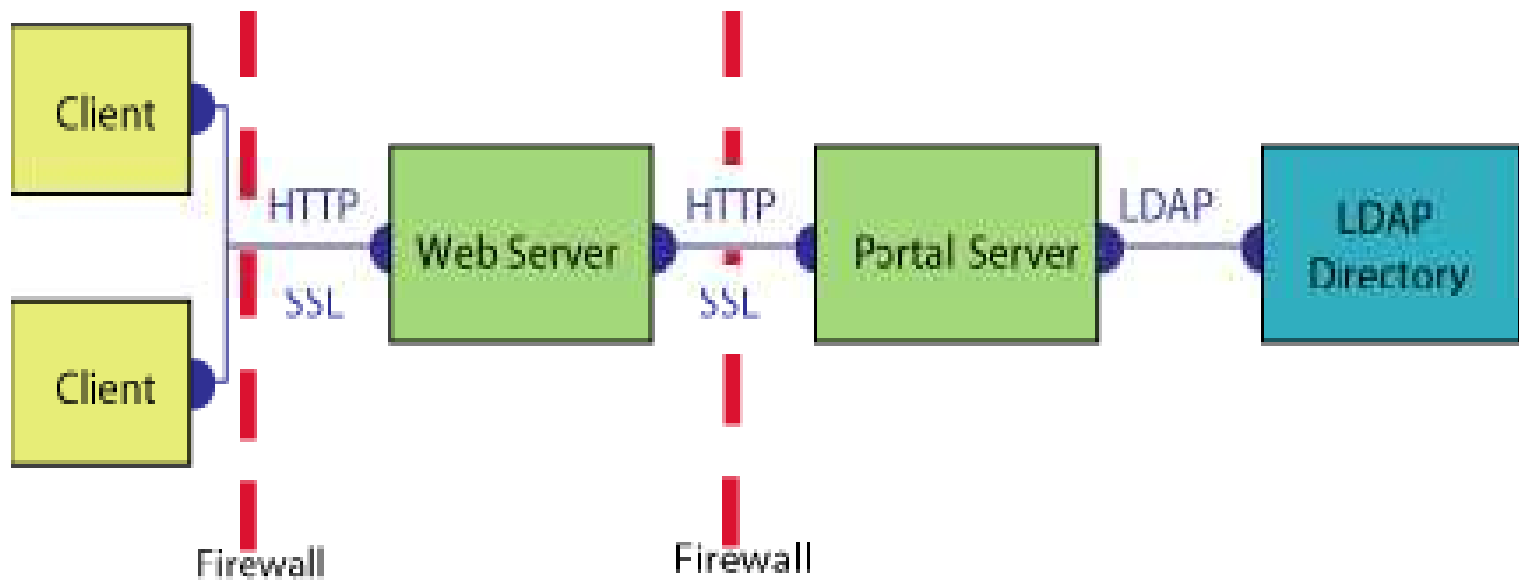
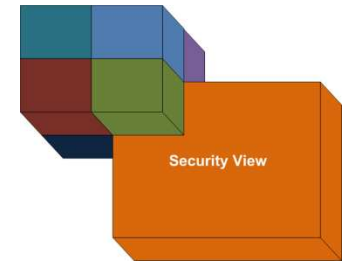

Portal Resource Security

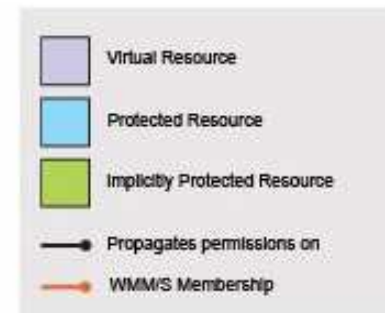
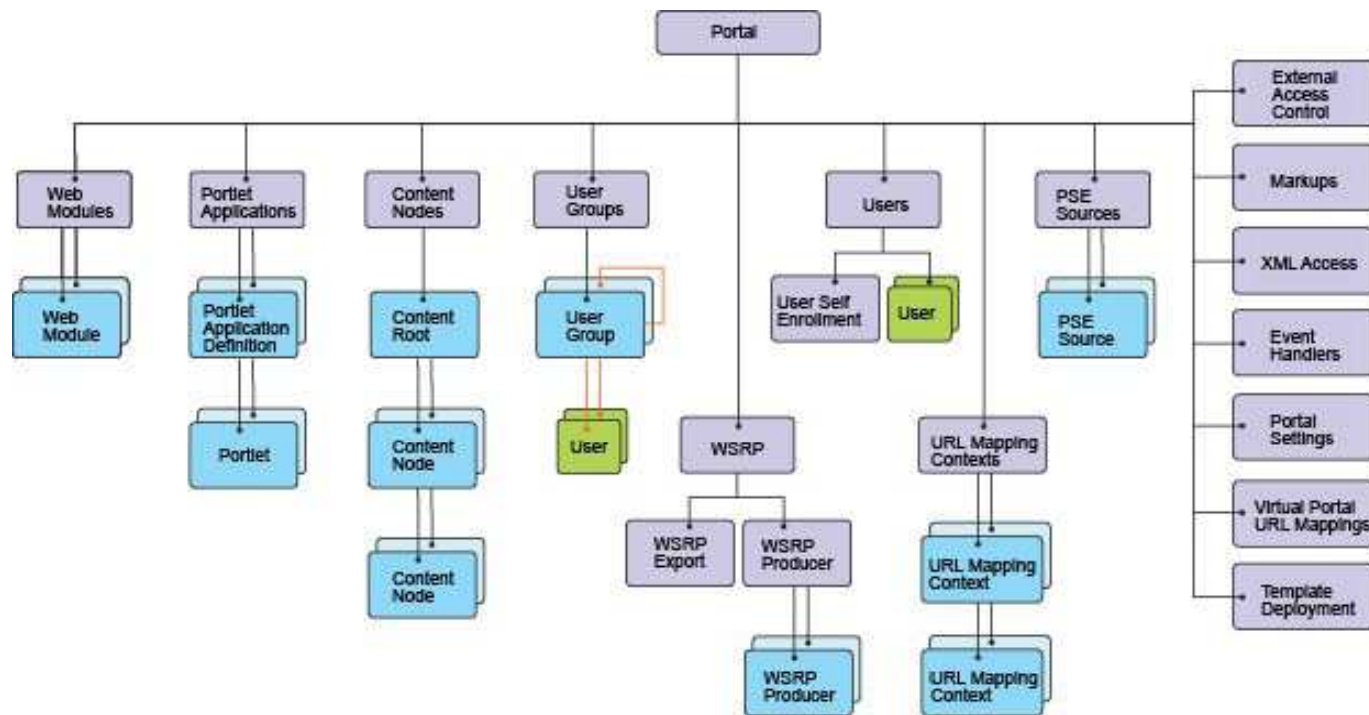
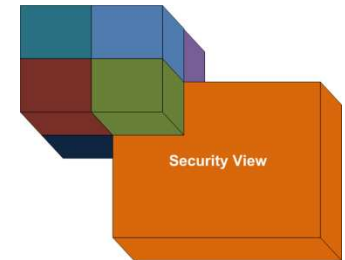

WSRP Security View

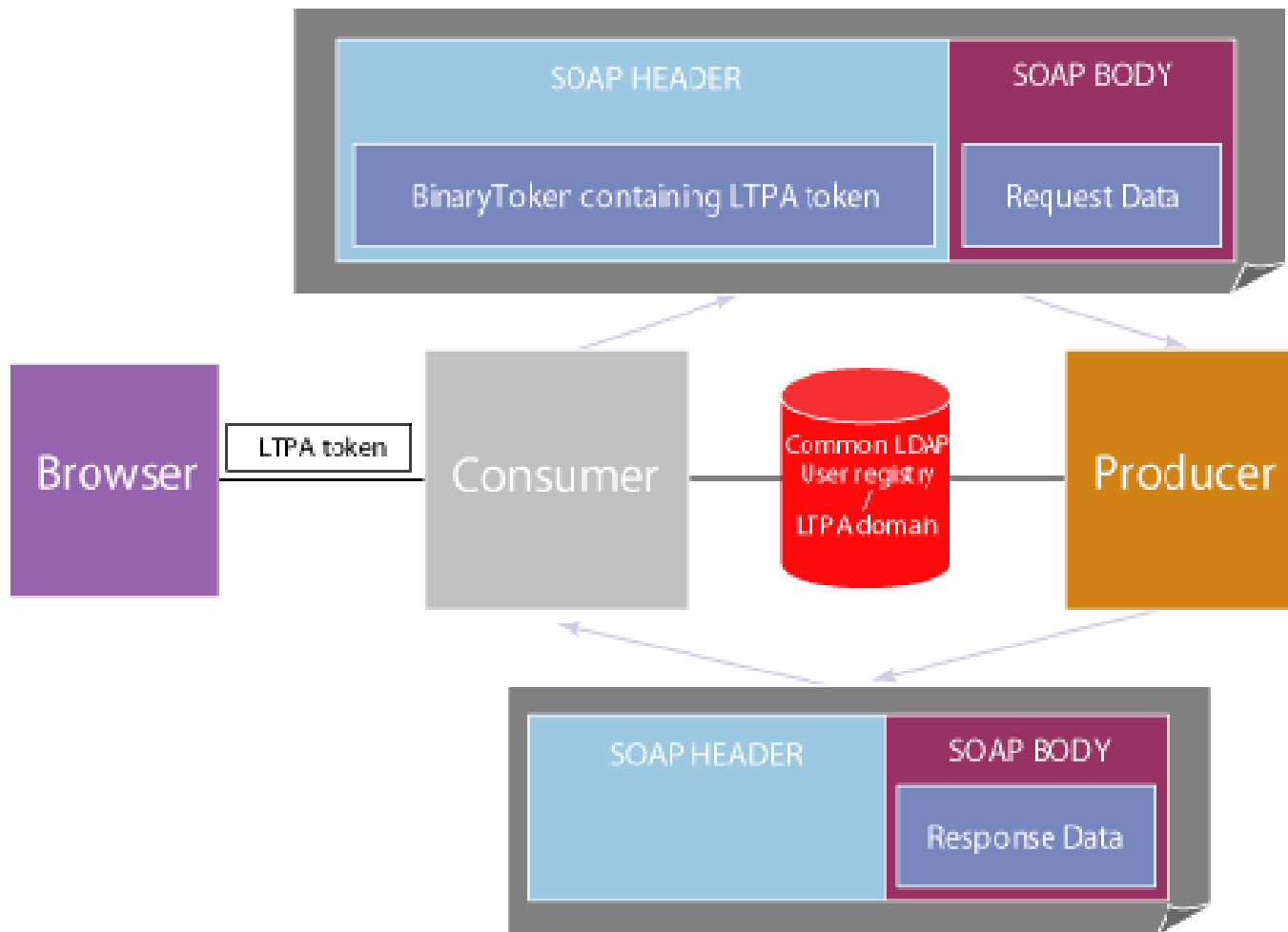
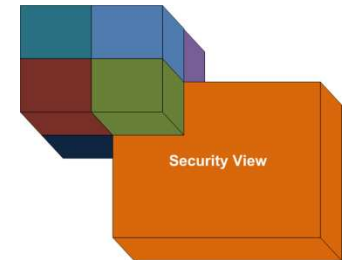

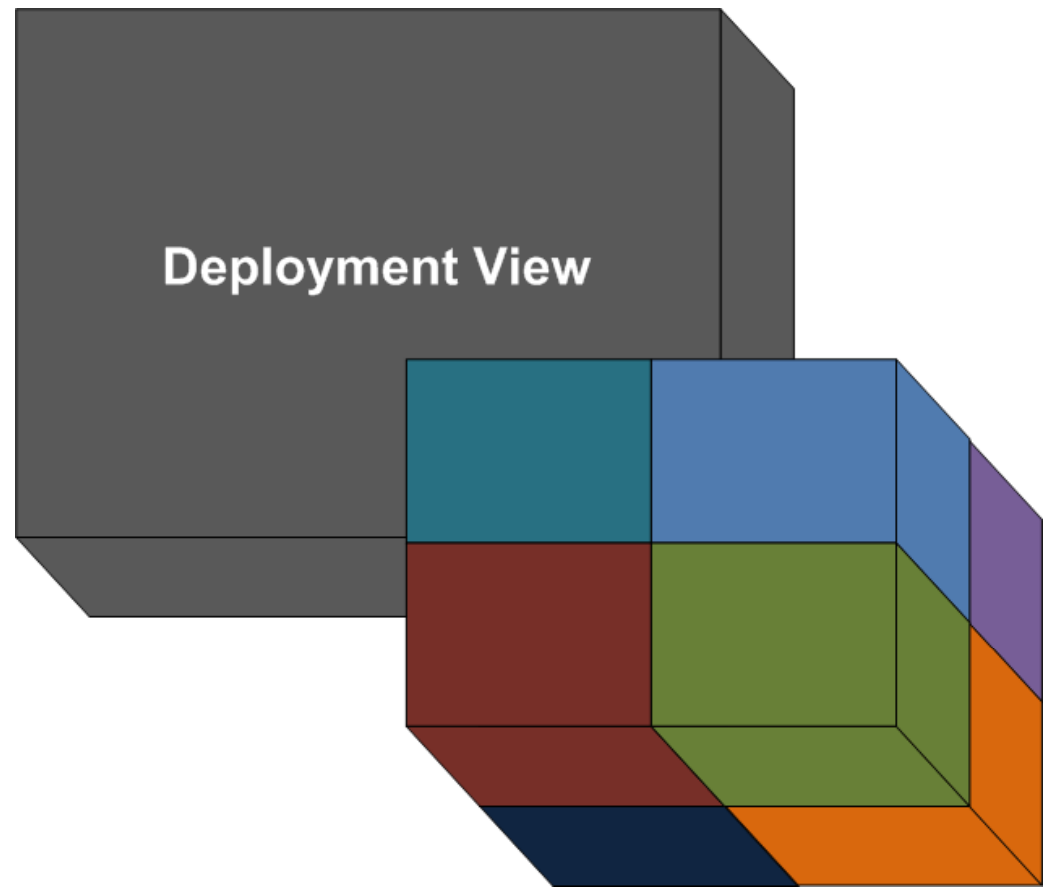

Architectural Views

DEPLOYMENT VIEW

Software Topology

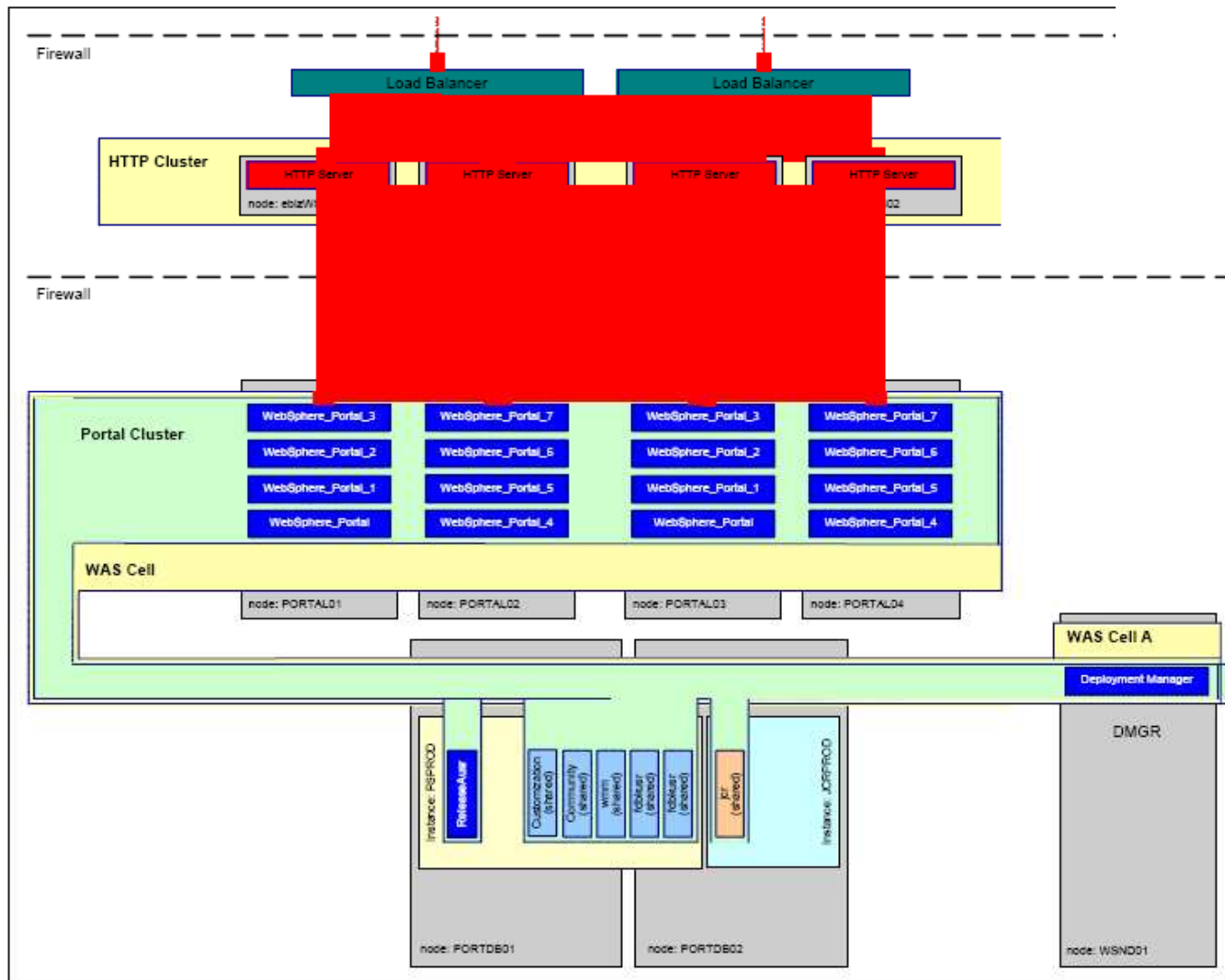
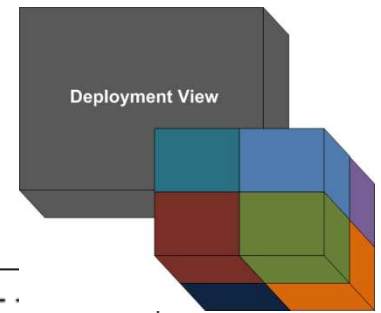

Sizing View

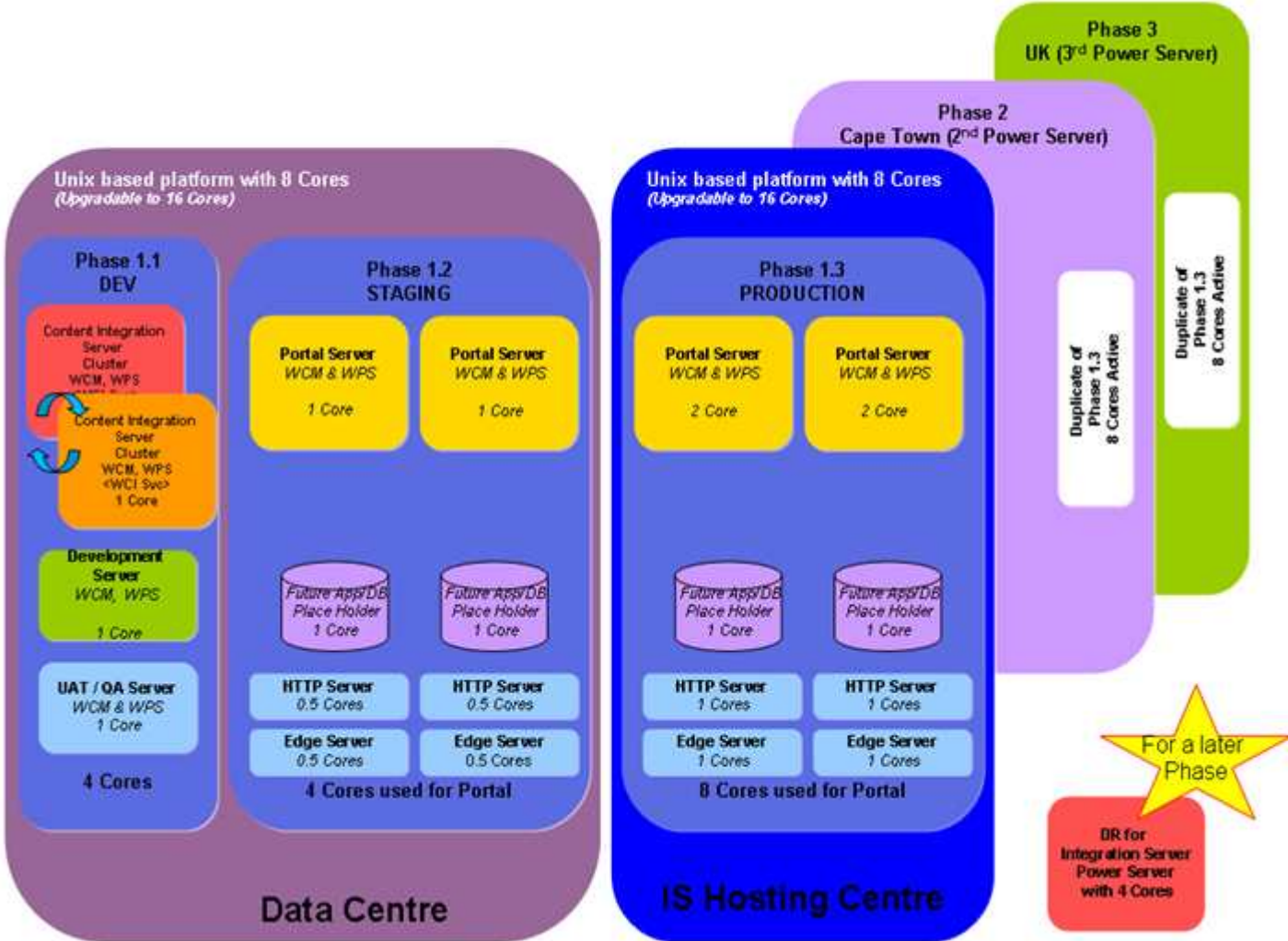
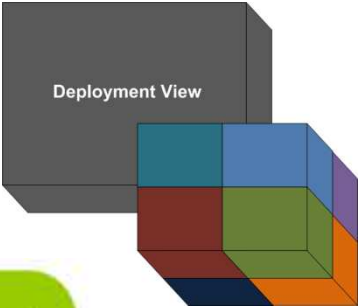

Q & A

Thank You!